

USER MANUAL

MAVERICK SILENS 2 PROFILE



Edition Notes

The Maverick Silens 2 Profile User Manual includes a description, safety precautions, installation, programming, operation, and maintenance instructions for the Maverick Silens 2 Profile as of the release date of this edition.

Trademarks

CHAUVET, the Chauvet logo, and Maverick Silens 2 Profile are registered trademarks or trademarks of Chauvet & Sons, LLC (d/b/a Chauvet and Chauvet Lighting) in the United States and other countries. Other company and product names and logos referred to herein may be trademarks of their respective companies.

Copyright Notice

The works of authorship contained in this manual, including, but not limited to, all designs, texts, and images are owned by Chauvet.

© **Copyright 2021 Chauvet & Sons, LLC. All rights reserved.**

Electronically published by Chauvet in the United States of America.

Manual Use

Chauvet authorizes its customers to download and print this manual for professional information purposes only. Chauvet expressly prohibits the usage, copy, storage, distribution, modification, or printing of this manual or its content for any other purpose without written consent from Chauvet.

Document Printing

For best results, print this document in color, on letter size paper (8.5 x 11 in), double-sided. If using A4 paper (210 x 297 mm), configure the printer to scale the content accordingly.

Intended Audience

Any person installing, operating, and/or maintaining this product should completely read through the guide that shipped with the product, as well as this manual, before installing, operating, or maintaining this product.

Disclaimer

Chauvet believes that the information contained in this manual is accurate in all respects. However, Chauvet assumes no responsibility and specifically disclaims any and all liability to any party for any loss, damage or disruption caused by any errors or omissions in this document, whether such errors or omissions result from negligence, accident, or any other cause. Chauvet reserves the right to revise the content of this document without any obligation to notify any person or company of such revision; however, Chauvet has no obligation to make, and does not commit to make, any such revisions. Download the latest version from www.chauvetprofessional.com.

Document Revision

This Maverick Silens 2 Profile User Manual is the 6th edition of this document. Go to www.chauvetprofessional.com for the latest version.

TABLE OF CONTENTS

1. Before You Begin	1
What Is Included	1
Claims	1
Text Conventions	1
Symbols	1
FCC Compliance	1
RF Exposure Warning for North America and Australia	1
Safety Notes	2
Personal Safety	2
Mounting and Rigging	2
Power and Wiring	2
Operation	2
Expected LED Lifespan	2
2. Introduction	3
Description	3
Features	3
Product Overview	3
Product Dimensions	4
3. Setup	5
AC Power	5
AC Plug	5
Fuse Replacement	5
Remote Device Management (RDM)	5
USB Software Update	5
Mounting	6
Orientation	6
Rigging	6
Procedure	6
Signal Connections	7
Control Personalities	7
DMX Linking	7
Art-Net™ Connection	7
sACN Connection	7
Connection Diagram	7
4. Operation	8
Touchscreen Control Panel	8
Control Panel Description	8
Battery-Powered Display	8
Home Screen	8
Control Panel Lock	8
Followspot Mode	8
Menu Map	9
Configuration (DMX, Art-Net™, sACN)	14
Control Mode	14
Control Personalities	14
Starting Address	14
Network Setup	14
IP Mode	14
Universe	14
Manual IP Address	14
Subnet Mask	14
Control Channel Assignments and Values	15
41CH	15
32CH	18
Configuration (Settings)	21
Absolute Silence	21
Steady	21
Red Shift	21
Pan Reverse	21
Tilt Reverse	21
Screen Reverse	21

Pan Angle.....	21
Tilt Angle	21
Blackout on Movement.....	21
Touchscreen Calibration	22
Touchscreen Lock.....	22
Swap Pan and Tilt.....	22
CRMX Reset	22
Display Backlight Timer.....	22
Loss of Data	22
Dimmer Curve	22
LED Frequency	22
Preset Selection	22
Preset Synchronization	23
Reset Function	23
Factory Reset.....	23
Test Mode	23
Auto Test.....	23
Manual Test	23
System Information	24
Offset Mode (Zero Adjust).....	24
Web Server	24
Color Wheel	25
Gobo Dimensions.....	25
Gobo Designs	26
Gobo Replacement	27
Procedure	27
Diagram	27
5. Maintenance.....	28
Product Maintenance	28
6. Technical Specifications.....	29
7. Returns	30
8. Contact Us.....	31

Before You Begin

1. Before You Begin

What Is Included

- Maverick Silens 2 Profile
- Seetronic Powerkon IP20 power cord
- Gel frame and gel frame holder
- 2 spare gobo holders
- 2 Omega brackets with mounting hardware
- Quick Reference Guide

Claims

Carefully unpack the product immediately and check the container to make sure all the parts are in the package and are in good condition.



If the box or the contents (the product and included accessories) appear damaged from shipping, or show signs of mishandling, notify the carrier immediately, not Chauvet. Failure to report damage to the carrier immediately may invalidate your claim. In addition, keep the box and contents for inspection.

For other issues, such as missing components or parts, damage not related to shipping, or concealed damage, file a claim with Chauvet within 7 days of delivery.

Text Conventions

Convention	Meaning
1–512	A range of values
50/60	A set of values of which only one can be chosen
Settings	A menu option not to be modified
<ENTER>	A key to be pressed on the product's control panel

Symbols

Symbol	Meaning
	Critical installation, configuration, or operation information. Not following these instructions may make the product not work, cause damage to the product, or cause harm to the operator.
	Important installation or configuration information. The product may not function correctly if this information is not used.
	Useful information.



Any reference to data or power connections in this manual assumes the use of Seetronic IP-rated cables.



The term “DMX” used throughout this manual refers to the USITT DMX512-A digital data transmission protocol.

FCC Compliance

This device complies with Part 15 Part B of the FCC rules. Operation is subject to the following two conditions:

1. This device may not cause harmful interference, and
2. This device must accept any interference received, including interference that may cause undesired operation.

Any changes or modifications not expressly approved by the party responsible for compliance could void the user's authority to operate the equipment.

RF Exposure Warning for North America and Australia

Warning! This equipment complies with FCC radiation exposure limits set forth for an uncontrolled environment. This equipment should be installed and operated with a minimum distance of 20 cm between the radiator and your body. This transmitter must not be co-located or operating in conjunction with any other antenna or transmitter.

Safety Notes

Read all the following safety notes before working with this product. These notes contain important information about the installation, usage, and maintenance of this product.



This product contains no user-serviceable parts. Any reference to servicing in this User Manual will only apply to properly trained, certified technicians. Do not open the housing or attempt any repairs.



All applicable local codes and regulations apply to proper installation of this product.

Personal Safety

- Avoid direct eye exposure to the light source while the product is on.
- Always disconnect the product from the power source before cleaning or replacing the fuse.
- Always connect the product to a grounded circuit to avoid the risk of electrocution.
- Do not touch the product's housing when operating because it may be very hot.

Mounting and Rigging

- This product is intended for professional use only.
- This product is for indoor use only! To prevent risk of fire or shock, do not expose this product to rain or moisture. (IP20)
- CAUTION: When transferring product from extreme temperature environments, (e.g., cold truck to warm humid ballroom) condensation may form on the internal electronics of the product. To avoid causing a failure, allow product to fully acclimate to the surrounding environment before connecting it to power.
- Mount this product in a location with adequate ventilation, at least 20 in (50 cm) from adjacent surfaces.
- The product should be positioned so that prolonged staring into it at a distance closer than 11.5 ft (3.5) m is not expected.
- Make sure there are no flammable materials close to this product while it is operating.
- When hanging this product, always secure to a fastening device using a safety cable.
- Never carry the product by the power cord.

Power and Wiring

- Make sure the power cord is not crimped or damaged.
- Ensure that the product is connected to the proper voltage in accordance with the specifications in this manual or on the product's specification label.
- To eliminate unnecessary wear and improve its lifespan, during periods of non-use completely disconnect the product from power via breaker or by unplugging it.
- Never connect this product to a dimmer pack or rheostat.
- Make sure to replace the fuse with another of the same type and rating.
- Never disconnect this product by pulling or tugging on the power cable.

Operation

- Do not operate this product if there is damage on the housing, lenses, or cables. Have the damaged parts replaced by an authorized technician at once.
- If the external flexible cable or cord of this product is damaged, it shall be replaced with a special cable or cord exclusively available from the manufacturer or its service agent.
- The light source contained in this product shall only be replaced by the manufacturer, its service agent, or a similarly qualified person.
- Do not cover the ventilation slots when operating to avoid internal overheating.
- The maximum ambient temperature is 113 °F (45 °C). Do not operate the product at higher temperatures.
- The minimum startup temperature is -4°F (-20°C). Do not start the product at lower temperatures.
- The minimum ambient temperature is -22°F (-30°C). Do not operate the product at lower temperatures.
- In the event of a serious operation problem, stop using this product immediately!



If your Chauvet product requires service, contact Chauvet Technical Support.

Expected LED Lifespan

Over time, use and heat will gradually reduce LED brightness. Clustered LEDs produce more heat than single LEDs, contributing to shorter lifespans if always used at full intensity. The average LED lifespan is 40,000 to 50,000 hours. To extend LED lifespan, maintain proper ventilation around the product and limit the overall intensity.

2. Introduction

Description

The Maverick Silens 2 Profile is a completely silent, fully featured 560 W 95+ CRI LED yoke profile fixture, featuring CMY+CTO color mixing, a four-blade framing shutter system with rotation, a color wheel, animation wheel, a 10:1 zoom, prism, variable frosts, and two gobo wheels—one static and one rotating.

Features

- 100% convection cooled for zero fan noise along with silent motion and effects
- 16-bit dimming with selectable red shift of master dimmer for smooth control of fades
- Variable CMY+CTO color mixing system to create a wide pallet of colors
- One rotating and one static gobo wheel with unique, theatrical-based designs
- Interchangeable gobos between rotating and static wheels
- Variable frost system
- +60° or -60° rotation framing shutter system to allow for better framing positioning
- Animation wheel for enhanced visual effects
- Iris for total beam control
- RDM control over DMX for fixture reporting
- 5° to 50° zoom angle for variable beam sizes
- True-1-compatible power input and throughput
- Battery backup display with auto-rotate depending on fixture orientation

Product Overview

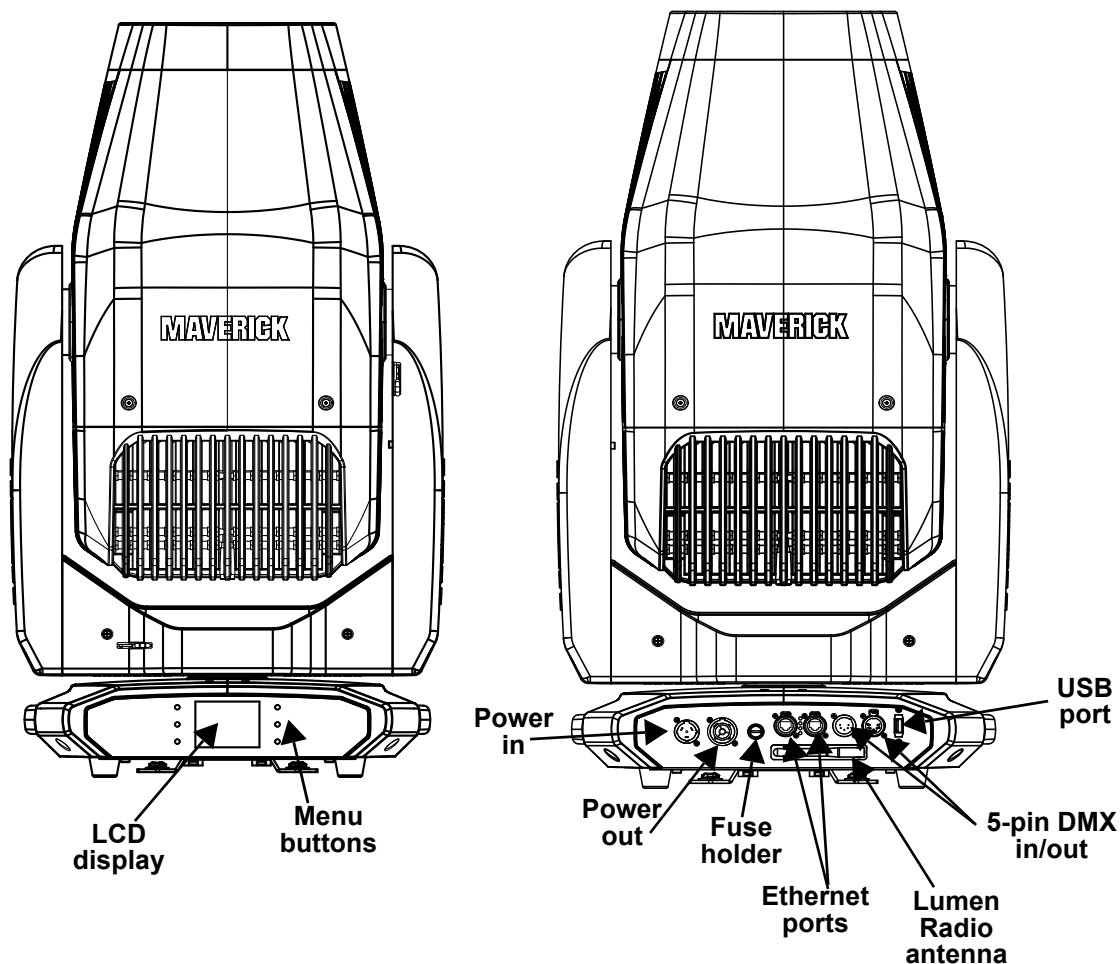

Product Dimensions

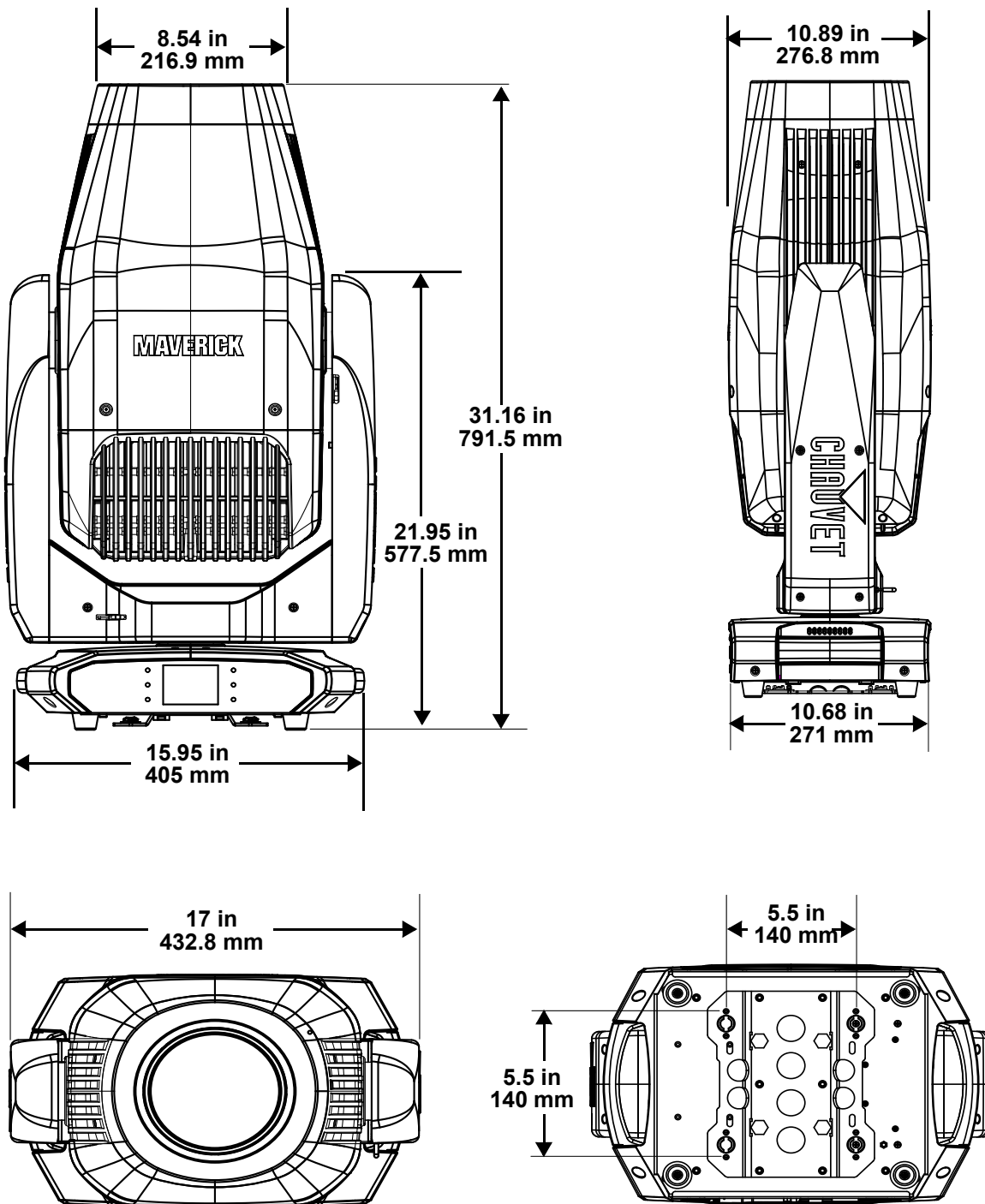

3. Setup

AC Power

The Maverick Silens 2 Profile has an auto-ranging power supply, and it can work with an input voltage range of 100 to 240 VAC, 50/60 Hz.

To determine the product's power requirements (e.g., circuit breaker, power outlet, and wiring), use the current value listed on the label affixed to the product's back panel, or refer to the product's specifications chart. The listed current rating indicates the product's average current draw under normal conditions.



- **Always connect the product to a protected circuit (a circuit breaker or fuse). Make sure the product has an appropriate electrical ground to avoid the risk of electrocution or fire.**
- **To eliminate unnecessary wear and improve its lifespan, during periods of non-use completely disconnect the product from power via breaker or by unplugging it.**



Never connect the product to a rheostat (variable resistor) or dimmer circuit, even if the rheostat or dimmer channel serves only as a 0 to 100% switch.

AC Plug

The Maverick Silens 2 Profile comes with a power input cord terminated with a Seetronic Powerkon A connector on one end and an Edison plug on the other end (U.S. market). If the power input cord that came with the product has no plug, or if the plug needs to be changed, use the table below to wire the new plug.

Connection	Wire (U.S.)	Wire (Europe)	Screw Color
AC Live	Black	Brown	Yellow or Brass
AC Neutral	White	Blue	Silver
AC Ground	Green/Yellow	Green/Yellow	Green

Fuse Replacement

1. Disconnect this product from the power outlet.
2. Using a flat-head screwdriver, unscrew the fuse holder cap from the housing.
3. Remove the blown fuse, and replace with another fuse of the same type and rating (F 10 A, 250 V).
4. Screw the fuse holder cap back in place and reconnect power.

Remote Device Management (RDM)

Remote Device Management, or RDM, is a standard for allowing DMX-enabled devices to communicate bi-directionally along existing DMX cabling. Check the DMX controller's User Manual or with the manufacturer as not all DMX controllers have this capability. The Maverick Silens 2 Profile supports RDM protocol that allows feedback to make changes to menu map options.

USB Software Update

The Maverick Silens 2 Profile allows for software update through USB using the built-in USB port. To update the software using USB flash drive, do the following:

1. Power on the fixture and plug the flash drive into the USB port.
2. Once the flash drive has been detected, the message "Upgrade Firmware" will be displayed. Press <ENTER>. If a different message appears on the display, search for the updated software in the **Menu (Updated Firmware)**. A list of the updated software files will be displayed.
3. Select the file that needs to be uploaded. The message "Are you sure?" will be displayed. Press <ENTER>.
4. If the selected file is correct, the upgrade will be completed. Restart the fixture. If the selected file is incorrect, the upgrade will fail, and the display will go back to the main interface. Repeat steps 1–3 using the correct file.



The .chl format file needs to be placed in the MAVERICK folder in the USB flash drive.

Mounting

Before mounting the product, read and follow the safety recommendations indicated in the [Safety Notes](#). For our CHAUVET Professional line of mounting clamps, go to <http://trusst.com/products/>.

Orientation

Always mount this product in a safe position, making sure there is adequate room for ventilation, configuration, and maintenance.

Rigging

Chauvet recommends using the following general guidelines when mounting this product.

- Before deciding on a location for the product, make sure there is easy access to the product for maintenance and programming purposes.
- Make sure that the structure onto which you are mounting the product can support the product's weight. See the [Technical Specifications](#) for weight information.
- When mounting the product overhead, always use a safety cable. Mount the product securely to a rigging point, whether an elevated platform or a truss.
- When rigging the product onto a truss, use a mounting clamp of appropriate weight capacity.

Procedure

The Maverick Silens 2 Profile comes with a bracket to which you can attach a mounting clamp directly. Mounting clamps are sold separately. Make sure the clamps are capable of supporting the weight of this product. Use at least two mounting points per product. For the CHAUVET Professional line of mounting clamps, go to <http://www.trusst.com/products>.

Mounting Diagram

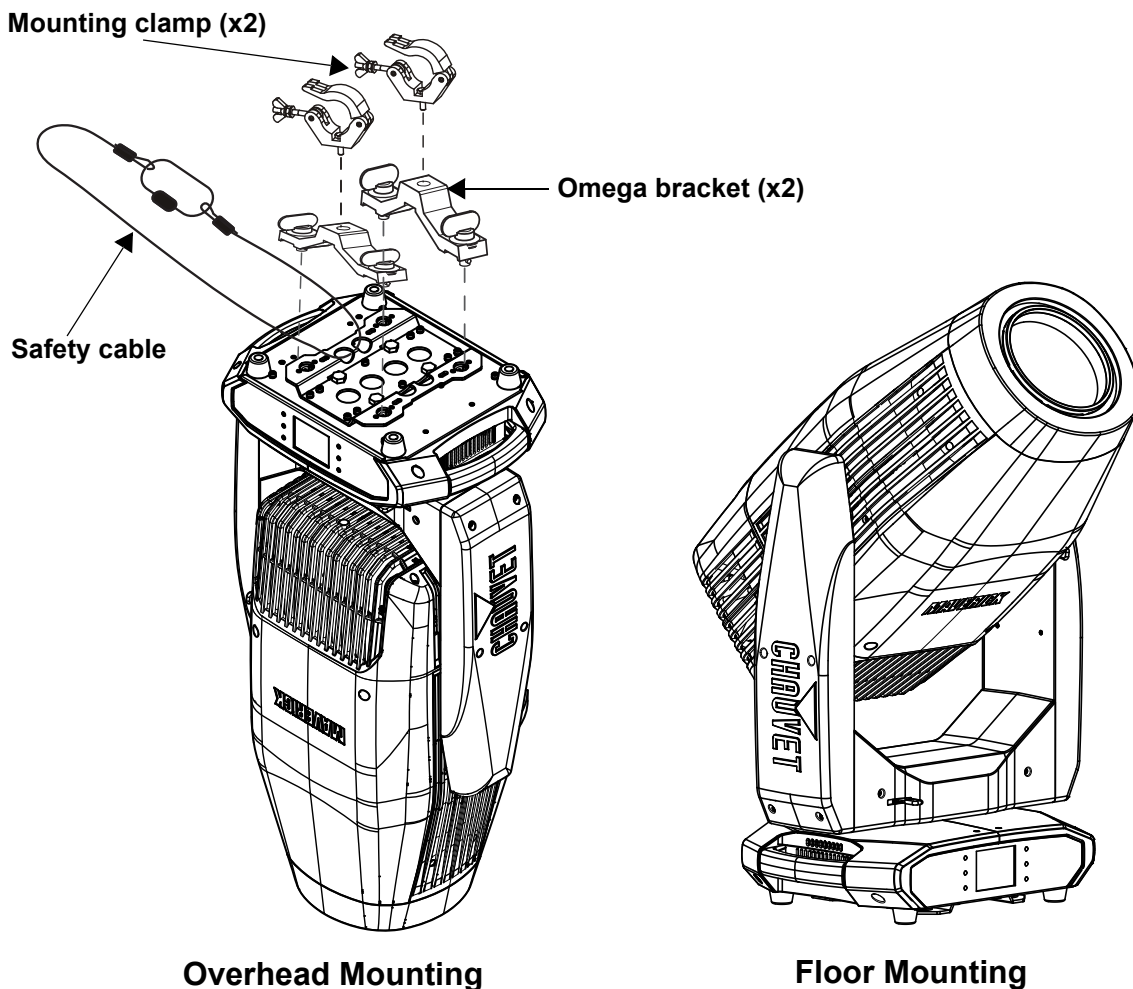

Signal Connections

The Maverick Silens 2 Profile can receive a DMX, Art-Net™, CRMX, or sACN, signal. The Maverick Silens 2 Profile has two Amphenol XLRnet through ports, and 5-pin DMX in and out ports. If using other compatible products with this product, you can control each individually with a single controller.

Control Personalities

The Maverick Silens 2 Profile uses a 5-pin DMX data connection, CRMX, Art-Net™, or sACN for its two control personalities: **Dmx Mode 32 CH** and **Dmx Mode 41 CH**.

- Refer to the [Operation](#) chapter to learn how to configure the Maverick Silens 2 Profile to work in these personalities.
- The [Control Channel Assignments and Values](#) section provides detailed information regarding the control personalities.



If you are not familiar with or need more information about DMX standards or the DMX cables needed to link this product to a DMX controller, download the DMX Primer from the Chauvet website: www.chauvetprofessional.com.

DMX Linking

You can link the Maverick Silens 2 Profile to a DMX controller using a 5-pin DMX connection or a CRMX connection. For more information about DMX, read the DMX primer at: https://www.chauvetprofessional.com/wp-content/uploads/2016/06/DMX_Primer.pdf.

Art-Net™ Connection

Art-Net™ is an Ethernet protocol that uses TCP/IP that transfers a large amount of DMX512 data using an Amphenol XLRnet RJ45 connection over a large network. An Art-Net™ protocol document is available from www.chauvetprofessional.com.

Art-Net™ designed by and copyright Artistic Licence Holdings Ltd.

sACN Connection

Streaming ACN, also known as ANSI E1.31, is an Ethernet protocol that uses the layering and formatting of Architecture for Control Networks to transport DMX512 data over IP or any other ACN compatible network.

Connection Diagram

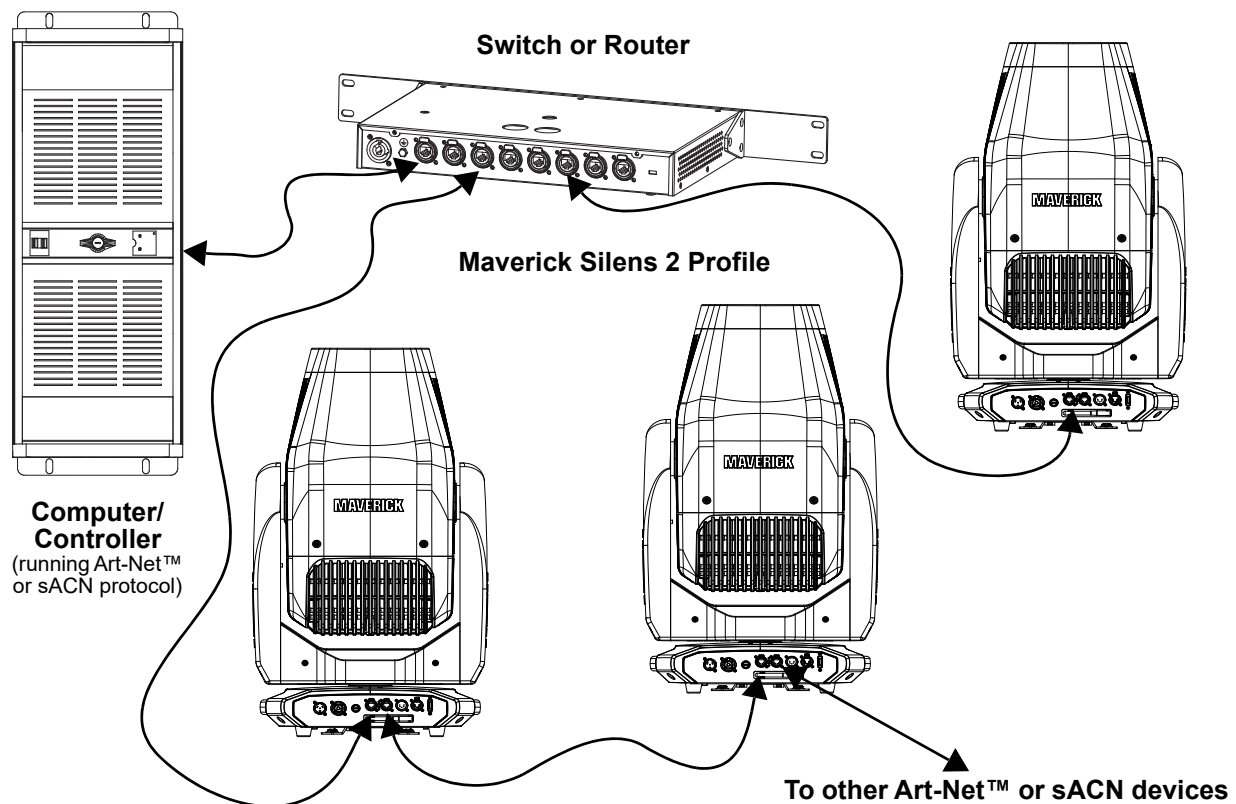







The three LED indicators in between the Ethernet through ports indicate a connection to a network and activity on that network. They do not indicate whether or not the Maverick Silens 2 Profile is receiving a signal from a controller.

4. Operation

Touchscreen Control Panel

The Maverick Silens 2 Profile has a touchscreen display and six control buttons. Navigate the menu structure by pressing the buttons, touching the images of the buttons on the sides of the display, or touching the desired menu option on the display directly. The touchscreen can be locked and calibrated through the Settings options in the menu (see [Touchscreen Calibration](#) and [Touchscreen Lock](#).)

Control Panel Description

Button	Function
	Navigates upwards through the menu list or increases the numeric value when in a function
	Exits from the current menu or function
	Navigates downwards through the menu list or decreases the numeric value when in a function
	Navigates leftwards through the menu list
	Enables the currently displayed menu or sets the currently selected value into the selected function
	Navigates rightwards through the menu list

Battery-Powered Display

The Maverick Silens 2 Profile has a battery-powered display that enables access to the menu when the product is powered off. Press and hold **<MENU>** until the display activates (approximately 15 seconds).

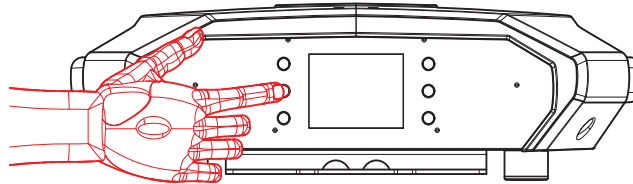

Home Screen

The Maverick Silens 2 Profile has a home screen that shows the current control protocols, personalities, starting addresses, IP addresses, and universes. To see the home screen, press **<MENU>** repeatedly until it shows on the display. From the home screen, touch any of the displayed control settings to immediately jump to that part of the menu, such as the personality, starting address, or universe, or press **<ENTER>** to reach the main menu.

Control Panel Lock

The setting locks or unlocks the control panel.

1. Go to the **Settings** main level.
2. Select the **Lock Screen** option.
3. Select **Off** (control panel stays unlocked) or **On** (locks control panel).



When the control panel lock is activated, the product will prompt for the passcode in order to access the menu. Enter the passcode: 0920

Followspot Mode

The followspot mode disables the pan and tilt motors, allowing the output of the product to be aimed by hand. To enable the followspot mode of the Maverick Silens 2 Profile, hold **<UP>** and **<LEFT>** while the product is powering on. When the product is turned off and back on, the pan and tilt will return to normal function.

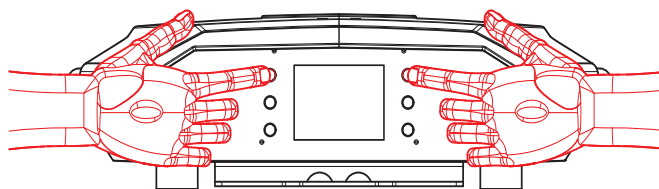

Menu Map

Refer to the Maverick Silens 2 Profile product page on www.chauvetprofessional.com for the latest menu map.

Main Level	Programming Levels		Description
Address	001–512		Sets the starting address
Network Setup	IP Mode	Manual	Manually set IP address
		DHCP	Network sets IP address
		Static	Product sets IP address
	Universe	000–255 (Art-Net™) 001–256 (sACN)	Sets the universe
	Ip	002.____.____.____	Sets the IP address in Manual mode
	SubMask	____.____.____.____	Sets the Subnet Mask in Manual mode
Personality	Dmx Mode 32 CH		Selects the 32-channel mode
	Dmx Mode 41 CH		Selects the 41-channel mode
Settings	Control Mode	DMX	Sets the control protocol
		CRMX	
		ArtNet	
		sACN	
	Absolute Silence	No	Enables/disables Absolute Silence mode
		Yes	
	Steady	Off	Disables Steady mode
		Steady Mode 1	Environment temperature 26 °C
		Steady Mode 2	Environment temperature 35 °C
	Red Shift	No	Mimics halogen lamp dimming
		Yes	
	Pan Reverse	No	Normal pan
		Yes	Reversed pan
	Tilt Reverse	No	Normal tilt
		Yes	Reversed tilt
	Screen Reverse	No	Normal display
		Yes	Inverted display
		Auto	Automatic display orientation
	Pan Angle	540	540° pan range
		360	360° pan range
		180	180° pan range
	Tilt Angle	270	270° tilt range
		180	180° tilt range
		90	90° tilt range
	BL. O. P/T Move	No	Do not black out while panning/tilting
		Yes	Blackout while panning/tilting
	BL. O. Color Move	No	Do not black out while color wheel moving
Yes		Blackout while color wheel moving	
BL. O. Gobo Move	No	Do not black out while gobo wheels moving	
	Yes	Blackout while gobo wheels moving	

Main Level	Programming Levels		Description
Settings (cont.)	Touch Calibration	No	Touchscreen calibration disabled
		Yes	Touchscreen calibration enabled
	Touch Lock	No	Touchscreen enabled
		Yes	Touchscreen disabled
	Lock Screen	Off	Lock the buttons and touch screen. Passcode: 0920
		On	
	Swap XY	No	Do not swap pan and tilt
		Yes	Pan controls tilt, tilt controls pan
	CRMX Reset	No	Do not reset CRMX
		Yes	Reset CRMX
	Display Timeout	30S	Display turns off after 30 seconds
		1M	Display turns off after 1 minute
		2M	Display turns off after 2 minutes
		On	Display stays on
	Loss of Data	Hold	Holds last signal received
		Close	Blacks out fixture
	Dimmer Curve	Linear	Set the dimmer curve
		Square	
		I Squa	
		SCurve	
	LED Frequency	20000Hz	Sets the LED frequency
		40000Hz	
	Preset Select	PRESET A	Recorded preset menu options
		PRESET B	
		PRESET C	
	Preset Sync	No	Allows recorded preset menu options to be transferred to other Maverick Silens 2 Profile fixtures in the DMX daisy chain
		Yes	
	Reset	Pan/Tilt	Yes/No
Iris/Prism			
Color/CMY			
Gobo/Gobo Rotate			
Frost			
Animation			
Zoom			
Entire Fixture			
Factory Settings	No	Reset to factory default settings	
	Yes		
Upgrade Firmware	No such file!	USB software upgrade	
	xxx.EKL		
	...		

Main Level	Programming Levels		Description	
Test	Auto Test	No	Auto test all functions	
		Yes		
	Manual Test	Pan	000-255	Manually control and test all settings through the control panel
		Pan Fine		
		Tilt		
		Tilt Fine		
		P/T Speed		
		Dimmer		
		Dimmer Fine		
		Shutter/Strobe		
		Virtual Strobe		
		Cyan		
		Magenta		
		Yellow		
		CTO		
		Color		
		Hue Adjustment		
		Red Shift		
		RGobo Wheel		
		Gobo Rotation		
		RGobo Wheel Index Fine		
		Static Gobo Wheel		
		Animation Wheel		
		Shutter Rotate		
		Shutter 1		
		Shutter 1-1		
		Shutter 2		
		Shutter 2-1		
		Shutter 3		
		Shutter 3-1		
		Shutter 4		
		Shutter 4-1		
	Focus			
Focus Fine				
Auto Focus				
Zoom				
Zoom Fine				
Prism				
Prism Rotation				
Iris				
Frost				
Frost Fine				

Main Level	Programming Levels		Description	
Information	Fixture Information	Ver	V_	Shows firmware version
		DMX Address	---	Shows current starting address
		Personality	---	Shows current personality
		Temperature	--°C/--°F	Shows current product temperature in °C
		Fixture Hours	-----	Shows number of hours product has been powered on
		Ip	-----	Shows current IP address
		SubMask	-----	Shows current Subnet Mask
		MAC	-----	Shows current MAC address
	Fan Information	Head Fan1 Speed	----	Shows speed of head fans in rpm
		Head Fan2 Speed	----	
		Head Fan3 Speed	----	
		Head Fan4 Speed	----	
	Error Information		-----	Shows any errors, or No Error!
	DMX Values	Pan	000-255	Shows all current values from input signals
		Pan Fine		
Tilt				
Tilt Fine				
P/T Speed				
Dimmer				
Dimmer Fine				
Shutter/Strobe				
Cyan				
Magenta				
Yellow				
CTO				
Color				
Hue Adjustment				
Red Shift				
Gobo 1				
Gobo1 Rotation				
Gobo1 Rotation Fine				
Static Gobo Wheel				

Operation

Main Level	Programming Levels		Description
Information (cont.)	DMX Values	Animation Wheel Shutters Rotate Shutter 1-1 Shutter 1-2 Shutter 2-1 Shutter 2-2 Shutter 3-1 Shutter 3-2 Shutter 4-1 Shutter 4-2 Focus Focus Fine Auto Focus Zoom Zoom Fine Prism Prism Rotation Iris Frost Frost Fine Control	000–255 Shows all current values from input signals

Configuration (DMX, Art-Net™, sACN)

Use control configurations to operate the product with a DMX, Art-Net™, or sACN controller.

Control Mode

The Maverick Silens 2 Profile works with wired DMX, CRMX, Art-Net™, and sACN control signals. To select which protocol to use:

1. Go to the **Settings** main level.
2. Select the **Control Mode** option.
3. Select the desired protocol, from **DMX**, **CRMX**, **ArtNet**, or **sACN**.



- See the [CRMX Reset](#) section for further setup of CRMX.
- See the [Network Setup](#) section for further setup of ethernet protocols (Art-Net™ or sACN).

Control Personalities

To set the control personality:

1. Go to the **Personality** main level.
2. Select the desired personality, from **Dmx Mode 32 CH** or **Dmx Mode 41 CH**.



- See the [Starting Address](#) section for the highest starting address you can select for each personality.
- Make sure that the starting addresses on the various products do not overlap due to the new personality setting.

Starting Address

Each product will respond to a unique starting address from the controller. All products with the same starting address will respond in unison. To set the starting address:

1. Go to the **Address** main level.
2. Select the starting address (**001–488**).
 - The highest recommended starting address for **Dmx Mode 32CH** is **481**.
 - The highest recommended starting address for **Dmx Mode 41CH** is **472**.

Network Setup

The Network Setup settings control the IP address, subnet mask, and universe of the product.

IP Mode

To choose how the IP address is set:

1. Go to the **Network Setup** main level.
2. Select the **IP Mode** option.
3. Select the desired IP mode, from **Manual** (to set a custom IP address), **DHCP** (the IP address is assigned by the connected network), or **Static** (the product uses a default, preset IP address).

Universe

To assign an Art-Net™ or sACN universe to the Maverick Silens 2 Profile:

1. Go to the **Network Setup** main level.
2. Select the **Universe** option.
3. Set the universe, from **000–255** (for Art-Net™) or from **001–256** (for sACN).

Manual IP Address

To set the IP address when the **IP Mode** is set to **Manual**:

1. Go to the **Network Setup** main level.
2. Select the **Ip** option.
3. Set the value of the IP address.

Subnet Mask

To set the subnet mask:

1. Go to the **Network Setup** main level.
2. Select the **SubMask** option.
3. Set the values of the subnet mask from **000–255**.

Operation

Control Channel Assignments and Values

41CH

Channel	Function	Value	Percent/Setting
1	Pan	000 ⇄ 255	0–100%
2	Pan fine	000 ⇄ 255	Fine control (16-bit)
3	Tilt	000 ⇄ 255	0–100%
4	Tilt fine	000 ⇄ 255	Fine control (16-bit)
5	Pan/tilt speed	000 ⇄ 255	Fast to slow
6	Dimmer	000 ⇄ 255	0–100%
7	Dimmer fine	000 ⇄ 255	Fine control (16-bit)
8	Shutter/Strobe	000 ⇄ 010	No function (shutter open)
		011 ⇄ 082	Shutter effect, slow to fast
		083 ⇄ 093	No function (shutter open)
		094 ⇄ 163	Pulse effect in sequences
		164 ⇄ 174	No function (shutter open)
		175 ⇄ 223	Random effect, slow to fast
		224 ⇄ 255	No function (shutter open)
9	Virtual strobe	000 ⇄ 004	No function
		005 ⇄ 010	Section 1 on
		011 ⇄ 015	Section 2 on
		016 ⇄ 020	Section 3 on
		021 ⇄ 025	Section 4 on
		026 ⇄ 030	Section 5 on
		031 ⇄ 070	Stop between sections 1–5 clockwise, fast to slow
		071 ⇄ 075	Stop
		076 ⇄ 116	Stop between sections 1–5 counterclockwise, slow to fast
		117 ⇄ 121	Stop
		122 ⇄ 162	Fade between sections 1–5 clockwise, fast to slow
		163 ⇄ 167	Stop
		168 ⇄ 208	Fade between sections 1–5 counterclockwise, slow to fast
		209 ⇄ 255	No function
10	Cyan	000 ⇄ 255	0–100%
11	Magenta	000 ⇄ 255	0–100%
12	Yellow	000 ⇄ 255	0–100%
13	CTO	000 ⇄ 255	0–100%
14	Color wheel	000 ⇄ 004	Open
		005 ⇄ 009	Red
		010 ⇄ 013	Orange
		014 ⇄ 018	Dark green
		019 ⇄ 022	Cyan
		023 ⇄ 027	Congo blue
		028 ⇄ 031	UV
		032 ⇄ 187	Split color
		188 ⇄ 219	Color scroll, fast to slow
		220 ⇄ 223	Stop
		224 ⇄ 255	Reverse color scroll, slow to fast
15	Hue adjustment	000 ⇄ 127	-25 to 0 green
		128 ⇄ 255	0 to +25 green
16	Red shift	000 ⇄ 010	No function
		011 ⇄ 127	Red shift off
		128 ⇄ 255	Red shift on

Channel	Function	Value	Percent/Setting
17	Rotating gobo wheel	000 ⇔ 005	Open
		006 ⇔ 010	Gobo 1 (Barking up a flaming river)
		011 ⇔ 015	Gobo 2 (Floyd)
		016 ⇔ 020	Gobo 3 (Sparse branches)
		021 ⇔ 025	Gobo 4 (Something linear)
		026 ⇔ 030	Gobo 5 (Super max)
		031 ⇔ 035	Gobo 6 (Windowpane)
		036 ⇔ 040	Gobo 7 (Shower glass)
		041 ⇔ 055	Gobo 1 shaking, slow to fast
		056 ⇔ 070	Gobo 2 shaking, slow to fast
		071 ⇔ 085	Gobo 3 shaking, slow to fast
		086 ⇔ 100	Gobo 4 shaking, slow to fast
		101 ⇔ 115	Gobo 5 shaking, slow to fast
		116 ⇔ 130	Gobo 6 shaking, slow to fast
		131 ⇔ 145	Gobo 7 shaking, slow to fast
		146 ⇔ 200	Gobo scroll, static to fast
201 ⇔ 255	Reverse gobo scroll, static to fast		
18	Gobo 1 rotation	000 ⇔ 191	Indexing
		192 ⇔ 221	Gobo rotation, fast to slow
		222 ⇔ 225	Stop
		226 ⇔ 255	Reverse gobo rotation, slow to fast
19	Gobo wheel 1 indexing fine	000 ⇔ 255	Fine control (16-bit)
20	Static gobo wheel	000 ⇔ 005	Open
		006 ⇔ 010	Gobo 1 (Dotty)
		011 ⇔ 015	Gobo 2 (Stones)
		016 ⇔ 020	Gobo 3 (Leafiness)
		021 ⇔ 025	Gobo 4 (Busted burlap)
		026 ⇔ 030	Gobo 5 (EVH)
		031 ⇔ 035	Gobo 6 (Basketcase)
		036 ⇔ 040	Gobo 7 (CaChow)
		041 ⇔ 045	Gobo 8 (Grass vignette)
		046 ⇔ 060	Gobo 1 shaking, slow to fast
		061 ⇔ 075	Gobo 2 shaking, slow to fast
		076 ⇔ 090	Gobo 3 shaking, slow to fast
		091 ⇔ 105	Gobo 4 shaking, slow to fast
		106 ⇔ 120	Gobo 5 shaking, slow to fast
		121 ⇔ 135	Gobo 6 shaking, slow to fast
		136 ⇔ 150	Gobo 7 shaking, slow to fast
151 ⇔ 165	Gobo 8 shaking, slow to fast		
166 ⇔ 210	Gobo scroll, static to fast		
211 ⇔ 255	Reverse gobo scroll, static to fast		
21	Animation wheel	000 ⇔ 003	Open / No function
		004 ⇔ 127	Clockwise rotation, fast to slow
		128 ⇔ 131	Stop
		132 ⇔ 255	Counterclockwise rotation, slow to fast
22	Framing shutter rotation	000 ⇔ 127	Rotation, left to center
		128	Stop
		129 ⇔ 255	Rotation, center to right
23	Framing shutter 1 movement	000 ⇔ 255	Movement, outward to inward
24	Framing shutter 1 swiveling	000 ⇔ 127	Swiveling from -25° to 0°
		128	0°
		129 ⇔ 255	Swiveling from 0° to +25°

Operation

Channel	Function	Value	Percent/Setting
25	Framing shutter 2 movement	000 ⇔ 255	Movement, outward to inward
26	Framing shutter 2 swiveling	000 ⇔ 127	Swiveling from -25° to 0°
		128	0°
26	Framing shutter 2 swiveling	129 ⇔ 255	Swiveling from 0° to +25°
27	Framing shutter 3 movement	000 ⇔ 255	Movement, outward to inward
28	Framing shutter 3 swiveling	000 ⇔ 127	Swiveling from -25° to 0°
		128	0°
28	Framing shutter 3 swiveling	129 ⇔ 255	Swiveling from 0° to +25°
29	Framing shutter 4 movement	000 ⇔ 255	Movement, outward to inward
30	Framing shutter 4 swiveling	000 ⇔ 127	Swiveling from -25° to 0°
		128	0°
30	Framing shutter 4 swiveling	129 ⇔ 255	Swiveling from 0° to +25°
31	Focus	000 ⇔ 255	0–100%
32	Focus fine	000 ⇔ 255	Fine control (16-bit)
		000	Auto focus off
33	Auto focus	001 ⇔ 007	4 m
		008 ⇔ 015	6 m
		016 ⇔ 023	8 m
		024 ⇔ 031	10 m
		032 ⇔ 039	12 m
		040 ⇔ 047	14 m
		048 ⇔ 055	16 m
		056 ⇔ 063	18 m
		064 ⇔ 071	4 m
		072 ⇔ 079	6 m
		080 ⇔ 087	8 m
		088 ⇔ 095	10 m
		096 ⇔ 103	12 m
		104 ⇔ 111	14 m
		112 ⇔ 119	16 m
		120 ⇔ 127	18 m
		128 ⇔ 255	Reserved
34	Zoom	000 ⇔ 255	0–100%
35	Zoom fine	000 ⇔ 255	Fine control (16-bit)
36	Prism	000 ⇔ 127	No function
		128 ⇔ 255	Prism effect
37	Prism rotation	000 ⇔ 127	Prism indexing
		128 ⇔ 189	Clockwise rotation, fast to slow
		190 ⇔ 193	Stop
		194 ⇔ 255	Counterclockwise rotation, slow to fast
38	Iris	000 ⇔ 192	Large to small
		193 ⇔ 213	Auto change, slow to fast
		214 ⇔ 234	Open, slow to fast
		235 ⇔ 255	Close, slow to fast
39	Frost	000 ⇔ 255	0–100%
40	Frost fine	000 ⇔ 255	Fine control (16-bit)

Channel	Function	Value	Percent/Setting
41	Control (hold for 3 seconds)	000 ⇔ 007	No function
		008 ⇔ 015	Reset all
		016 ⇔ 023	Pan & tilt reset
		024 ⇔ 031	Effects reset (prism, iris, frost)
		032 ⇔ 039	Gobo reset
		040 ⇔ 047	Shutter module reset
		048 ⇔ 055	Other reset (zoom, focus reset)
		056 ⇔ 063	Color reset (CMY + CTO + color)
		064 ⇔ 071	Absolute silence off
		072 ⇔ 079	Absolute silence on
		080 ⇔ 087	Steady off
		088 ⇔ 095	Steady mode 1 (environment temperature 26 °C)
		096 ⇔ 103	Steady mode 2 (environment temperature 35 °C)
		104 ⇔ 111	Linear dimmer
		112 ⇔ 119	Square dimmer curve
		120 ⇔ 127	Inverse square dimmer curve
		128 ⇔ 135	S-curve dimmer
136 ⇔ 143	Fast dimmer mode		
144 ⇔ 151	Smooth dimmer mode		
152 ⇔ 255	No function		

32CH

Channel	Function	Value	Percent/Setting
1	Pan	000 ⇔ 255	0–100%
2	Pan fine	000 ⇔ 255	Fine control (16-bit)
3	Tilt	000 ⇔ 255	0–100%
4	Tilt fine	000 ⇔ 255	Fine control (16-bit)
5	Dimmer	000 ⇔ 255	0–100%
6	Shutter/Strobe	000 ⇔ 010	No function (shutter open)
		011 ⇔ 082	Shutter effect, slow to fast
		083 ⇔ 093	No function (shutter open)
		094 ⇔ 163	Pulse effect in sequences
		164 ⇔ 174	No function (shutter open)
		175 ⇔ 223	Random effect, slow to fast
224 ⇔ 255	No function (shutter open)		
7	Cyan	000 ⇔ 255	0–100%
8	Magenta	000 ⇔ 255	0–100%
9	Yellow	000 ⇔ 255	0–100%
10	CTO	000 ⇔ 255	0–100%
11	Color wheel	000 ⇔ 004	Open
		005 ⇔ 009	Red
		010 ⇔ 013	Orange
		014 ⇔ 018	Dark green
		019 ⇔ 022	Cyan
		023 ⇔ 027	Congo blue
		028 ⇔ 031	UV
		032 ⇔ 187	Split color
		188 ⇔ 219	Color scroll, fast to slow
		220 ⇔ 223	Stop
		224 ⇔ 255	Reverse color scroll, slow to fast

Operation

Channel	Function	Value	Percent/Setting
12	Rotating gobo wheel	000 ⇄ 005	Open
		006 ⇄ 010	Gobo 1 (Barking up a flaming river)
		011 ⇄ 015	Gobo 2 (Floyd)
		016 ⇄ 020	Gobo 3 (Sparse branches)
		021 ⇄ 025	Gobo 4 (Something linear)
		026 ⇄ 030	Gobo 5 (Super max)
		031 ⇄ 035	Gobo 6 (Windowpane)
		036 ⇄ 040	Gobo 7 (Shower glass)
		041 ⇄ 055	Gobo 1 shaking, slow to fast
		056 ⇄ 070	Gobo 2 shaking, slow to fast
		071 ⇄ 085	Gobo 3 shaking, slow to fast
		086 ⇄ 100	Gobo 4 shaking, slow to fast
		101 ⇄ 115	Gobo 5 shaking, slow to fast
		116 ⇄ 130	Gobo 6 shaking, slow to fast
		131 ⇄ 145	Gobo 7 shaking, slow to fast
		146 ⇄ 200	Gobo scroll, static to fast
201 ⇄ 255	Reverse gobo scroll, static to fast		
13	Gobo 1 rotation	000 ⇄ 191	Gobo rotation, slow to fast
		192 ⇄ 223	Stop
		224 ⇄ 255	Reverse gobo rotation, slow to fast
14	Static gobo wheel	000 ⇄ 005	Open
		006 ⇄ 010	Gobo 1 (Dotty)
		011 ⇄ 015	Gobo 2 (Stones)
		016 ⇄ 020	Gobo 3 (Leafiness)
		021 ⇄ 025	Gobo 4 (Busted burlap)
		026 ⇄ 030	Gobo 5 (EVH)
		031 ⇄ 035	Gobo 6 (Basketcase)
		036 ⇄ 040	Gobo 7 (CaChow)
		041 ⇄ 045	Gobo 8 (Grass vignette)
		046 ⇄ 060	Gobo 1 shaking, slow to fast
		061 ⇄ 075	Gobo 2 shaking, slow to fast
		076 ⇄ 090	Gobo 3 shaking, slow to fast
		091 ⇄ 105	Gobo 4 shaking, slow to fast
		106 ⇄ 120	Gobo 5 shaking, slow to fast
		121 ⇄ 135	Gobo 6 shaking, slow to fast
		136 ⇄ 150	Gobo 7 shaking, slow to fast
151 ⇄ 165	Gobo 8 shaking, slow to fast		
166 ⇄ 210	Gobo scroll, static to fast		
211 ⇄ 255	Reverse gobo scroll, static to fast		
15	Animation wheel	000 ⇄ 003	Open / No function
		004 ⇄ 127	Clockwise rotation, fast to slow
		128 ⇄ 131	Stop
		132 ⇄ 255	Counterclockwise rotation, slow to fast
16	Framing shutter rotation	000 ⇄ 127	Rotation, left to center
		128	Stop
		129 ⇄ 255	Rotation, center to right
17	Framing shutter 1 movement	000 ⇄ 255	Movement, outward to inward
18	Framing shutter 1 swiveling	000 ⇄ 127	Swiveling from -25° to 0°
		128	0°
		129 ⇄ 255	Swiveling from 0° to +25°
19	Framing shutter 2 movement	000 ⇄ 255	Movement, outward to inward

Channel	Function	Value	Percent/Setting
20	Framing shutter 2 swiveling	000 ⇔ 127	Swiveling from -25° to 0°
		128	0°
		129 ⇔ 255	Swiveling from 0° to +25°
21	Framing shutter 3 movement	000 ⇔ 255	Movement, outward to inward
22	Framing shutter 3 swiveling	000 ⇔ 127	Swiveling from -25° to 0°
		128	0°
		129 ⇔ 255	Swiveling from 0° to +25°
23	Framing shutter 4 movement	000 ⇔ 255	Movement, outward to inward
24	Framing shutter 4 swiveling	000 ⇔ 127	Swiveling from -25° to 0°
		128	0°
		129 ⇔ 255	Swiveling from 0° to +25°
25	Focus	000 ⇔ 255	0–100%
26	Zoom	000 ⇔ 255	0–100%
27	Prism	000 ⇔ 127	No function
		128 ⇔ 255	Prism effect
28	Prism rotation	000 ⇔ 127	Prism indexing
		128 ⇔ 189	Clockwise rotation, fast to slow
		190 ⇔ 193	Stop
		194 ⇔ 255	Counterclockwise rotation, slow to fast
29	Iris	000 ⇔ 192	Large to small
		193 ⇔ 213	Auto change, slow to fast
		214 ⇔ 234	Open, slow to fast
		235 ⇔ 255	Close, slow to fast
30	Frost	000 ⇔ 255	0–100%
31	Frost fine	000 ⇔ 255	Fine control (16-bit)
32	Control (hold for 3 seconds)	000 ⇔ 007	No function
		008 ⇔ 015	Reset all
		016 ⇔ 023	Pan & tilt reset
		024 ⇔ 031	Effects reset (prism, iris, frost)
		032 ⇔ 039	Gobo reset
		040 ⇔ 047	Shutter module reset
		048 ⇔ 055	Other reset (zoom, focus reset)
		056 ⇔ 063	Color reset (CMY + CTO + color)
		064 ⇔ 071	Absolute silence off
		072 ⇔ 079	Absolute silence on
		080 ⇔ 087	Steady off
		088 ⇔ 095	Steady mode 1 (environment temperature 26 °C)
		096 ⇔ 103	Steady mode 2 (environment temperature 35 °C)
		104 ⇔ 111	Linear dimmer
		112 ⇔ 119	Square dimmer curve
		120 ⇔ 127	Inverse square dimmer curve
		128 ⇔ 135	S-curve dimmer
		136 ⇔ 143	Fast dimmer mode
		144 ⇔ 151	Smooth dimmer mode
		152 ⇔ 255	No function

Operation

Configuration (Settings)

Absolute Silence

Absolute Silence slows the pan/tilt and all the moving components inside the fixture to make the unit as absolutely silent as possible while operating. To enable or disable Absolute Silence mode:

1. Go to the **Settings** main level.
2. Select the **Absolute Silence** option.
3. Select from **No** (disables Absolute Silence mode) or **Yes** (enables Absolute Silence mode).

Steady

Steady mode controls the output of the fixture to minimize any drop in output for thermal control. The settings for the Steady mode are based on the ambient temperature where the fixture is in. The hotter the ambient temperature, the dimmer the output. To select the correct Steady mode option:

1. Go to the **Settings** main level.
2. Select the **Steady** option.
3. Select from **Off** (disables Steady mode), **Steady Mode 1** (environment temperature 26 °C), or **Steady Mode 2** (environment temperature 35 °C).

Red Shift

The Red Shift function allows the light in the fixture to mimic halogen lamp dimming. To enable or disable the Red Shift function:

1. Go to the **Settings** main level.
2. Select the **Red Shift** option.
3. Select from **No** (disables Red Shift function) or **Yes** (enables Red Shift function).

Pan Reverse

To set the orientation of the pan:

1. Go to the **Settings** main level.
2. Select the **Pan Reverse** option.
3. Select from **No** (normal pan motion) or **Yes** (reversed pan motion).

Tilt Reverse

To set the orientation of the tilt:

1. Go to the **Settings** main level.
2. Select the **Tilt Reverse** option.
3. Select from **No** (normal tilt motion) or **Yes** (reversed tilt motion).

Screen Reverse

To set the orientation of the display:

1. Go to the **Settings** main level.
2. Select the **Screen Reverse** option.
3. Select from **No** (right-side up), **Yes** (upside-down), or **Auto** (changes depending on the orientation of the product).

Pan Angle

To set the range of motion the pan is permitted:

1. Go to the **Settings** main level.
2. Select the **Pan Angle** option.
3. Select from **540** (540°), **360** (360°), or **180** (180°).

Tilt Angle

To set the range of motion the tilt is permitted:

1. Go to the **Settings** main level.
2. Select the **Tilt Angle** option.
3. Select from **270** (270°), **180** (180°), or **90** (90°).

Blackout on Movement

To set the Maverick Silens 2 Profile to black out on pan or tilt movement, color wheel movement, or gobo wheel movement:

1. Go to the **Settings** main level.
2. Select the **BL. O. P/T Move** (blackout on pan or tilt movement), **BL. O. Color Move** (blackout on color wheel movement), or **BL. O. Gobo Move** (blackout on gobo wheel movement) option.
3. Select from **No** (no blackout on selected movement) or **Yes** (blackout during the selected movement).

Touchscreen Calibration

If the touchscreen is not responding correctly, it may need to be calibrated. To do so:

1. Go to the **Settings** main level.
2. Select the **Touch Calibration** option.
3. Select from **No** (do not calibrate) or **Yes** (calibrate).
4. Follow the instructions on the display.

Touchscreen Lock

To lock the touchscreen and limit the display to operation by the menu buttons:

1. Go to the **Settings** main level.
2. Select the **Touch Lock** option.
3. Select from **No** (do not lock the touchscreen) or **Yes** (lock the touchscreen).

Swap Pan and Tilt

To switch the pan and tilt functions so that what normally controls the pan will control the tilt, and what controls the tilt will control the pan, do the following:

1. Go to the **Settings** main level.
2. Select the **Swap XY** option.
3. Select from **No** (do not swap) or **Yes** (swap so pan controls tilt and tilt controls pan).

CRMX Reset

To reset the CRMX connection and allow the Maverick Silens 2 Profile to connect to a CRMX transmitter:

1. Go to the **Settings** main level.
2. Select the **CRMX Reset** option.
3. Select from **No** (do not reset) or **Yes** (reset the CRMX connection).



Follow instructions in the manual or guide for the CRMX controller being used to connect it to the receiver in the Maverick Silens 2 Profile.

Display Backlight Timer

To set the length of time before an inactive display will turn off:

1. Go to the **Settings** main level.
2. Select the **Display Timeout** option.
3. Select the length of the backlight timer, from **30S** (30 seconds), **1M** (1 minute), **5M** (5 minutes), or **On** (always on).

Loss of Data

To set how the product reacts to a loss in control signal data:

1. Go to the **Settings** main level.
2. Select the **Loss of Data** option.
3. Select from **Hold** (holds the last values received before signal loss) or **Close** (blacks out the product).

Dimmer Curve

To set the dimmer curve:

1. Go to the **Settings** main level.
2. Select the **Dimmer Curve** option.
3. Select the dimmer curve, from **Linear**, **Square**, **I Squa**, or **SCurve**.

LED Frequency

To adjust the LED frequency of the product:

1. Go to the **Settings** main level.
2. Select the **LED Frequency** option.
3. Select from **20000Hz** or **40000Hz**.

Preset Selection

To select a preset configuration of menu options:

1. Go to the **Settings** main level.
2. Select the **Preset Select** option.
3. Select from **PRESET A** (default), **PRESET B**, or **PRESET C**.



- **Changes to settings automatically save to the currently selected preset option.**
- **If no preset option has been selected, changes to settings save to PRESET A.**
- **After selecting a preset option, the product will restart.**

Operation

Preset Synchronization

To transfer saved preset options from one Maverick Silens 2 Profile to another:

1. Connect the Maverick Silens 2 Profile products to receive the preset options by a DMX daisy chain.
2. Make the Maverick Silens 2 Profile with the preset options to transfer the first in the DMX daisy chain.
3. Power on all of the products.
4. Set all of the products to a [Control Mode](#) other than **CRMX** (i.e., **DMX**, **ArtNet**, or **sACN**).
5. On the Maverick Silens 2 Profile with the preset options, go to the **Settings** main level.
6. Select the **Preset Sync** option.
7. Select **No** (to cancel) or **Yes** (to transfer the preset options to the connected products).



- **All menu configurations are transferred except for the IP address.**
- **ONLY connect Maverick Silens 2 Profile products for this function!**

Reset Function

To reset specific functions or the entire product:

1. Go to the **Settings** main level.
2. Select the **Reset Function** option.
3. Select the functions to reset, from **Pan/Tilt**, **Iris/Prism**, **Color/CMY**, **Shutters**, **Gobo/Gobo Rotate**, **Frost**, **Animation**, **Zoom**, or **Entire Fixture**.
4. Select **No** (to cancel) or **Yes** (to reset the selected functions).

Factory Reset

To reset the product to factory default settings:

1. Go to the **Settings** main level.
2. Select the **Factory Reset** option.
3. Select **No** (to cancel) or **Yes** (to reset the product configuration to default factory settings).

Test Mode

Auto Test

To have the Maverick Silens 2 Profile automatically test all functions one after the other:

1. Go to the **Test** main level.
2. Select the **Auto Test** option.

Manual Test

To manually test an individual function of the Maverick Silens 2 Profile:

1. Go to the **Test** main level.
2. Select the **Manual Test** option.
3. Select a function to test. (Available functions are: **Pan**, **Pan Fine**, **Tilt**, **Tilt Fine**, **P/T Speed**, **Dimmer**, **Dimmer Fine**, **Shutter/Strobe**, **Virtual Strobe**, **Cyan**, **Magenta**, **Yellow**, **CTO**, **Color**, **Hue Adjustment**, **Red Shift**, **Rotating Gobo Wheel**, **Rotating Gobo Wheel Index Fine**, **Static Gobo Wheel**, **Animation Wheel**, **Shutter Rotate**, **Shutter 1**, **Shutter 1-1**, **Shutter 2**, **Shutter 2-1**, **Shutter 3**, **Shutter 3-1**, **Shutter 4**, **Shutter 4-1**, **Focus**, **Focus Fine**, **Auto Focus**, **Zoom**, **Zoom Fine**, **Prism**, **Prism Rotation**, **Iris**, **Frost**, and **Frost Fine**)
4. Increase or decrease the value of the selected function from **000–255** to test it.

System Information

The information section of the menu displays statistics and the current status of the product's various functions. To view these information sections:

1. Go to the **Information** main level.
2. Select which information to view, from **Fixture Information** (shows the firmware version, DMX address, temperature, running time, IP address, Subnet Mask, and MAC address), **Error Information** (shows any error the product has), or **DMX Values** (shows the current values of all signal input channels).
3. If necessary, scroll up and down to view all information available in the selected option.

Offset Mode (Zero Adjust)

The Offset mode provides fine adjustments for the home position of every moving part in the optical path and pan and tilt movements. To adjust these options and prevent borders from showing or reduction of the light output:

1. From the main level screen, press and hold **<MENU>** until the passcode screen appears.
2. Enter the passcode: **0920** and press **<ENTER>**.
3. Select the "zero" position to adjust, from **PAN, TILT, COLOR, GOBO, GOBO ROTATE, GOBO2, ANIMATION, FOCUS-GOBO, FOCUS-GOBO2, ZOOM, PRISM, PRISM2, PRISM ROT, IRIS, FROST, FROST2, CRI FILTER, CYAN, MAGENTA, YELLOW, CTO, MAC4, MAC5, or MAC6**.
4. Adjust the "zero" position for the selected function from **000–255**.

Web Server

The Maverick Silens 2 Profile Web Server can be accessed by any computer on the same network as the product. It allows network access to system information and settings, such as control setup, manual testing of all functions, firmware updates, and the ability to change the Web Server password.

1. Connect the product to power.
2. Set the [Control Mode](#) to **ArtNet** and the [IP Mode](#) to **Static**.
3. Connect the product to a Windows computer with a network cable.
4. On the computer, set the first value of the IP address of the new network to match the first value of the IP address of the product. The IP address of the product is displayed on the [Home Screen](#).
5. Enter the IP address of the product into the URL bar of a web browser on the computer.
6. Enter both the user name and password as **admin** to log in.

Information

The Information page on the Web Server displays the current settings and the system information of the Maverick Silens 2 Profile.

Setup

The Setup page on the Web Server provides options for control, similar to the **Setup** menu on the product. Click **Save Settings** to send the new configuration to the product.

Manual Test

The Manual Test page on the Web Server allows all output functions of the product to be controlled through the browser. To set all functions back to default, click **Reset**.

Firmware Update

The Upgrade page on the Web Server allows the product to be updated with the latest firmware. Go to <https://www.chauvetprofessional.com> to download firmware updates.

Security

The Security page on the Web Server gives the option to change the password to the connected product's web server. Enter the old password (**admin**, by default) and the new password twice, then click **Save Settings** to change the password.

Operation

Color Wheel

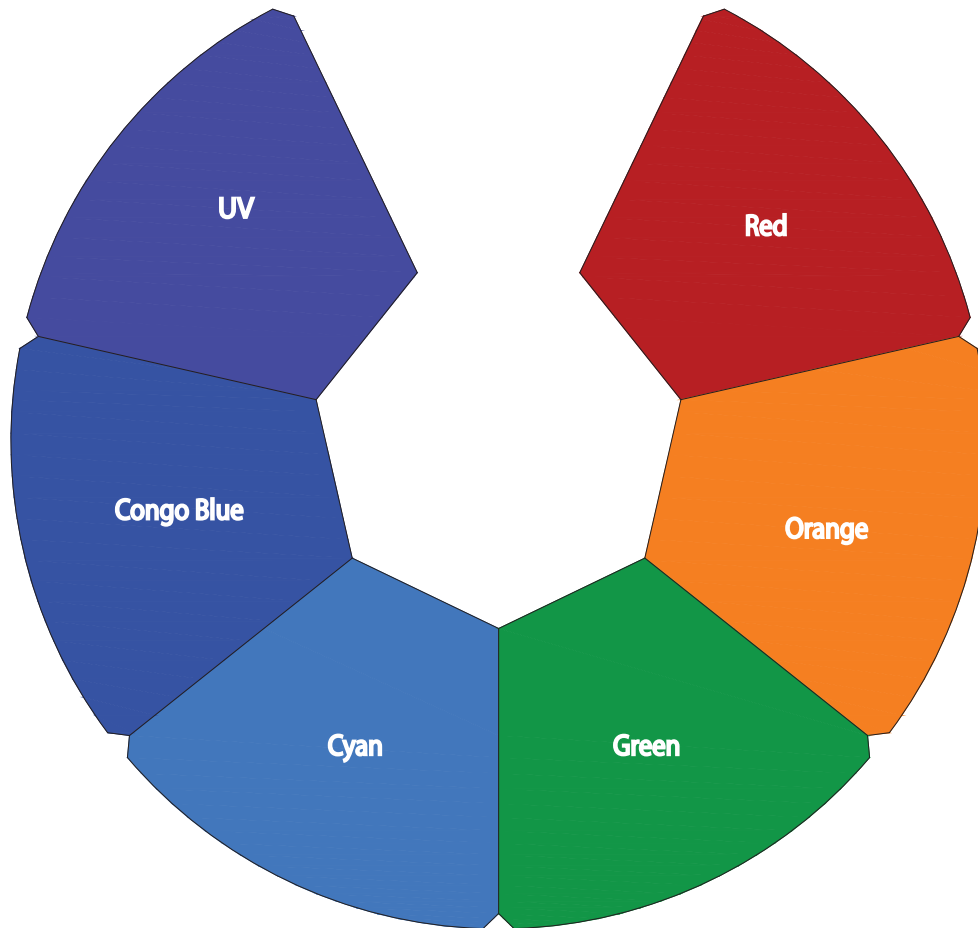

Gobo Dimensions

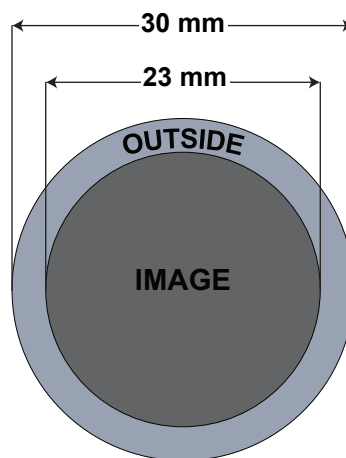

Gobo Designs

Rotating gobo wheel



Barking up a flaming river
(glass gobo)

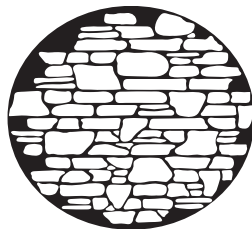

Floyd
(glass gobo)



Sparse braches
(glass gobo)



Something linear
(glass gobo)

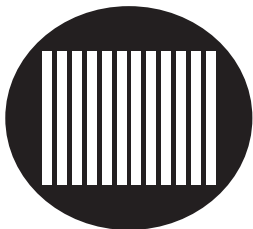

Super Max
(metal or glass gobo)

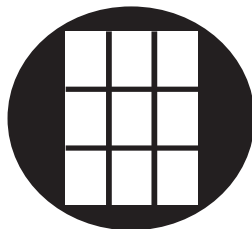

Window pane
(metal or glass gobo)

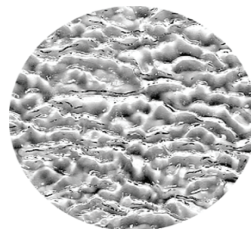

Shower glass
(textured glass)

Static gobo wheel

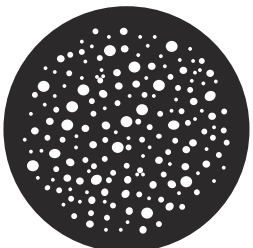

Dotty
(glass gobo)

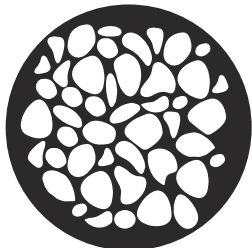

Stones
(metal or glass gobo)

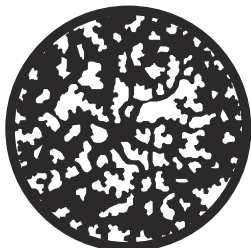

Leafiness
(metal or glass gobo)



Busted burlap
(glass gobo)



EVH
(glass gobo)

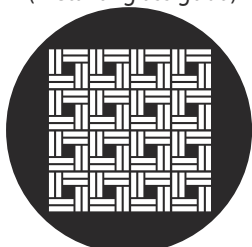

Basketcase
(metal or glass gobo)

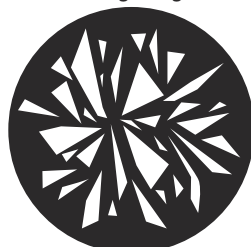

CaChow
(metal or glass gobo)

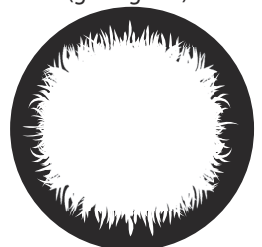

Grass vignette
(glass gobo)

Operation

Gobo Replacement

The gobos in gobo wheel 1 are removable from their gobo holders. This operation is quite simple, although it requires the technician to carefully follow the recommended procedure.

- **Make sure to disconnect the product's power cord before replacing a gobo.**
- **Always replace a gobo with a gobo of the same dimensions.**
- **When inserting a glass gobo, always make sure that the shiny side of the gobo (glass base) faces the lamp. This provides a layer of protection against the high temperature from the lamp.**

Procedure

1. Turn the product off and disconnect it from the power outlet.
2. Open the head cover by loosening the screws on the top cover.
3. Separate the gobo holder away from the gobo wheel by pushing it toward the front of the moving head (direction 1 in the diagram). Be careful not to push the gobo out of the gobo holder.
4. Extract the gobo holder by pulling it outward (direction 2 in the diagram).
5. On a flat surface, remove the expansion ring that holds the gobo in place and remove the gobo from the gobo holder.
6. Insert a new gobo and hold it in place with the expansion ring.
7. Slide the tip of the gobo holder under the pressure plate near the center of the gobo wheel.
8. Push the gobo holder inwards. **DO NOT** force the gobo holder into the gobo wheel slot. If correctly installed, the gobo holder should easily slide into the gobo wheel slot.

Diagram

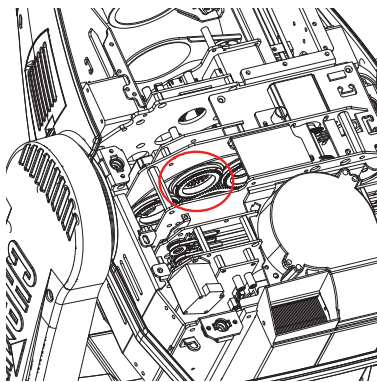

Locate

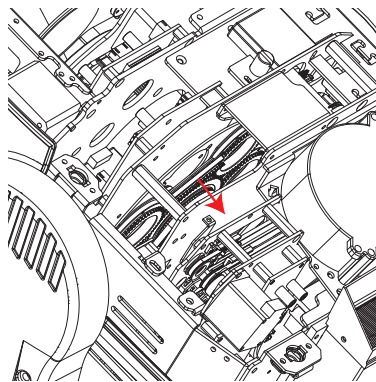

Pull back

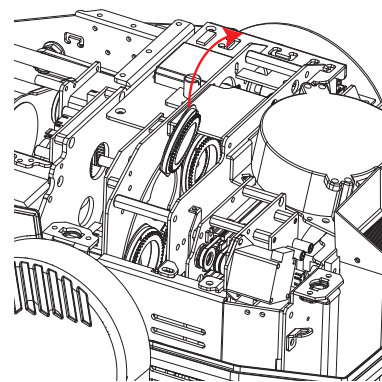

Remove

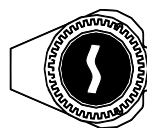
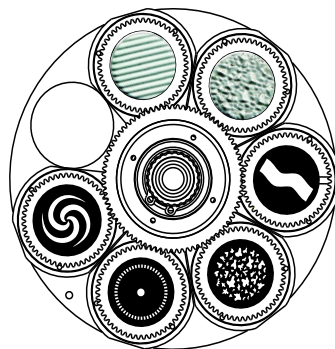

Gobo holder

Gobo

Retaining ring

5. Maintenance

Product Maintenance

Dust build-up reduces light output performance and can cause overheating. This can lead to reduction of the light source's life and/or mechanical wear. To maintain optimum performance and minimize wear, clean your lighting products at least twice a month. However, be aware that usage and environmental conditions could be contributing factors to increase the cleaning frequency.

To clean the product, follow the instructions below:

1. Unplug the product from power.
2. Wait until the product is at room temperature.
3. Use a vacuum (or dry compressed air) and a soft brush to remove dust collected on the external surface/vents.
4. Clean all transparent surfaces with a mild soap solution, ammonia-free glass cleaner, or isopropyl alcohol.
5. Apply the solution directly to a soft, lint free cotton cloth or a lens cleaning tissue.
6. Softly drag any dirt or grime to the outside of the transparent surface.
7. Gently polish the transparent surfaces until they are free of haze and lint.



Always dry the transparent surfaces carefully after cleaning them.



Do not spin the cooling fans with compressed air. Damage may result.

Technical Specifications

6. Technical Specifications

Dimensions and Weight

Length	Width	Height	Weight
17 in (433 mm)	10.8 in (276 mm)	31.1 in (792 mm)	75.5 lb (34.4 kg)

Note: Dimensions in inches are rounded.

Power

Power Supply Type	Range	Voltage Selection
Switching (internal)	100 to 240 VAC, 50/60 Hz	Auto-ranging

Parameter	100 V, 60 Hz	120 V, 60 Hz	208 V, 60 Hz	230 V, 50 Hz	240 V, 50 Hz
Consumption	650 W	640 W	639 W	648 W	654 W
Operating current	6.53 A	5.45 A	3.10 A	2.82 A	2.75 A
Power linking	13.6 A (2 products)	13.6 A (2 products)	13.6 A (4 products)	13.6 A (4 products)	13.6 A (4 products)

Power I/O	U.S./Worldwide	UK/Europe
Power input connector	Seetronic Powerkon A	Seetronic Powerkon A
Power cord plug	Edison (U.S.)	Local plug

Light Source

Type	Color	Quantity	Power	Current	Lifespan
LED	Cool white	1	500 W	15.5 A	30,000 hours
	RGB	1	60 W	3.2 A	50,000 hours

Photometrics

Beam Angle	Field Angle	Zoom Angle	Illuminance @ 5 m (6.4°)	Illuminance @ 5 m (53.7°)
5° to 50°	6° to 54°	6° to 54°	29,598 lux	640 lux

Thermal

Maximum External Temperature	Cooling System
113 °F (45 °C)	Convection

DMX

I/O Connector	Channel Range
3 and 5-pin XLR	32 or 41 channels

Art-Net™/sACN

I/O Connector	Channel Range
Amphenol XLR Net RJ45 in/out	32 or 41 channels

Ordering

Product Name	Item Name	Item Code	UPC Number
Maverick Silens 2 Profile	MAVERICKSILENS2PROFILE	03011615	781462219635



UL 1573
CSA C22.2 No. 166
E113093

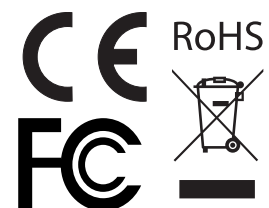

Returns

Send the product prepaid, in the original box, and with the original packing and accessories. Chauvet will not issue call tags.

Call Chauvet and request a Return Merchandise Authorization (RMA) number before shipping the product. Be prepared to provide the model number, serial number, and a brief description of the cause(s) for the return.

To submit a service request online, go to www.chauvetprofessional.com/service-request.

Clearly label the package with an RMA number. Chauvet will refuse any product returned without an RMA number.



Write the RMA number on a properly affixed label. DO NOT write the RMA number directly on the box.

Before sending the product, clearly write the following information on a piece of paper and place it inside the box:

- Your name
- Your address
- Your phone number
- RMA number
- A brief description of the problem

Be sure to pack the product properly. Any shipping damage resulting from inadequate packaging will be your responsibility. FedEx packing or double-boxing are recommended.



Chauvet reserves the right to use its own discretion to repair or replace returned product(s).

Contact Us

General Information	Technical Support
Chauvet World Headquarters	
Address: 5200 NW 108th Ave. Sunrise, FL 33351 Voice: (954) 577-4455 Fax: (954) 929-5560 Toll Free: (800) 762-1084	Voice: (844) 393-7575 Fax: (954) 756-8015 Email: chauvetcs@chauvetlighting.com Website: www.chauvetprofessional.com
Chauvet Europe Ltd	
Address: Unit 1C Brookhill Road Industrial Estate Pinxton, Nottingham, UK NG16 6NT Voice: +44 (0) 1773 511115 Fax: +44 (0) 1773 511110	Email: UKtech@chauvetlighting.eu Website: www.chauvetprofessional.eu
Chauvet Europe BVBA	
Address: Stokstraat 18 9770 Kruishoutem Belgium Voice: +32 9 388 93 97	Email: BNLtech@chauvetlighting.eu Website: www.chauvetprofessional.eu
Chauvet France	
Address: 3, Rue Ampère 91380 Chilly-Mazarin France Voice: +33 1 78 85 33 59	Email: FRtech@chauvetlighting.fr Website: www.chauvetprofessional.eu
Chauvet Germany	
Address: Bruno-Bürgerl-Str. 11 28759 Bremen Germany Voice: +49 421 62 60 20	Email: DEtech@chauvetlighting.de Website: www.chauvetprofessional.eu
Chauvet Mexico	
Address: Av. de las Partidas 34 - 3B (Entrance by Calle 2) Zona Industrial Lerma Lerma, Edo. de México, CP 52000 Voice: +52 (728) 690-2010	Email: servicio@chauvet.com.mx Website: www.chauvetprofessional.mx

Visit the applicable website above to verify our contact information and instructions to request support. Outside the U.S., U.K., Ireland, Benelux, France, Germany, or Mexico, contact the dealer of record.