

# MAVERICK

## MK2 PROFILE

### User Manual

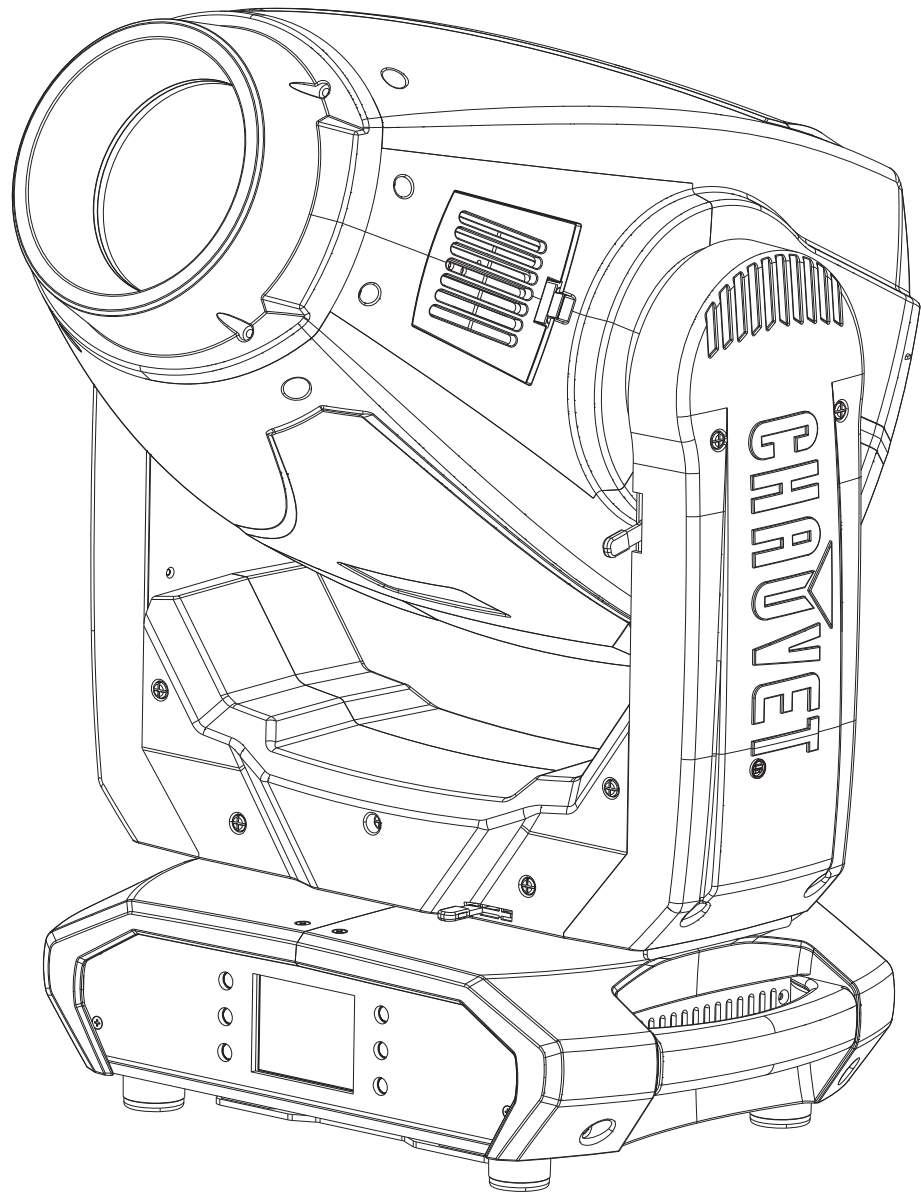

## EDITION NOTES

The Maverick MK2 Profile User Manual includes a description, safety precautions, installation, programming, operation and maintenance instructions for the Maverick MK2 Profile as of the release of this edition.

### Trademarks

CHAUVET, the Chauvet logo and Maverick MK2 Profile are registered trademarks or trademarks of Chauvet & Sons, LLC (d/b/a Chauvet and Chauvet Lighting) in the United States and other countries. Other company and product names and logos referred to herein may be trademarks of their respective companies.

### Copyright Notice

The works of authorship contained in this manual, including, but not limited to, all design, text and images are owned by Chauvet.

© Copyright 2017 Chauvet & Sons, LLC. All rights reserved.

Electronically published by Chauvet in the United States of America.

### Manual Use

Chauvet authorizes its customers to download and print this manual for professional information purposes only. Chauvet expressly prohibits the usage, copy, storage, distribution, modification, or printing of this manual or its content for any other purpose without written consent from Chauvet.

### Document Printing

For best results, print this document in color, on letter size paper (8.5 x 11 in), double-sided. If using A4 paper (210 x 297 mm), configure the printer to scale the content accordingly.

### Intended Audience

Any person installing, operating, and/or maintaining this product should completely read through the guide that shipped with the product, as well as this manual, before installing, operating, or maintaining this product.

### Disclaimer

Chauvet believes that the information contained in this manual is accurate in all respects. However, Chauvet assumes no responsibility and specifically disclaims any and all liability to any party for any loss, damage or disruption caused by any errors or omissions in this document, whether such errors or omissions result from negligence, accident or any other cause. Chauvet reserves the right to revise the content of this document without any obligation to notify any person or company of such revision, however, Chauvet has no obligation to make, and does not commit to make, any such revisions. Download the latest version from [www.chauvetprofessional.com](http://www.chauvetprofessional.com)

### Document Revision

This Maverick MK2 Profile User Manual is the 1<sup>st</sup> edition of this document. Go to [www.chauvetprofessional.com](http://www.chauvetprofessional.com) for the latest version.

TABLE OF CONTENTS

<b>1. Before You Begin</b> .....	4
What Is Included .....	4
Claims .....	4
Manual Conventions .....	4
Symbols .....	4
Safety Notes.....	5
Personal Safety.....	5
Mounting and Rigging .....	5
Power and Wiring.....	5
Operation .....	5
Expected LED Lifespan.....	5
<b>2. Introduction</b> .....	6
Description .....	6
Features.....	6
Product Overview.....	7
Product Dimensions.....	8
<b>3. Setup</b> .....	9
AC Power.....	9
AC Plug.....	9
Fuse Replacement.....	9
Mounting .....	10
Orientation.....	10
Rigging.....	10
Procedure.....	10
DMX Linking.....	11
DMX Personalities.....	11
Remote Device Management (RDM).....	11
Signal Connections .....	11
Art-Net™ Connection.....	11
sACN Connection.....	11
Connection Diagram .....	11
<b>4. Operation</b> .....	12
Control Panel Operation.....	12
Menu Map .....	12
Operating Settings Configuration .....	17
Home Screen .....	17
Start Address .....	17
Network Setup.....	17
IP Mode.....	17
Universe .....	18
Artnet IP Address .....	18
Subnet Mask .....	19
Personality .....	19
Settings .....	20
Control Mode.....	20
Pan/Tilt Orientation .....	20
Display Orientation.....	20
Pan/Tilt Angle Range .....	20
Blackout on Pan/Tilt Movement .....	21
Blackout on Color Movement.....	21
Blackout on Gobo Movement.....	21
Touchscreen Calibration .....	21

Touchscreen Lock.....	21
Lock the Screen.....	22
Swap Pan and Tilt.....	22
Pan/Tilt Speed.....	22
WDMX Reset.....	22
Backlight Timer.....	22
Loss of Data.....	23
Fan Speed.....	23
Dimmer Curve.....	23
Dimmer Speed.....	23
Pulse Width Modulation.....	23
Smart Zoom.....	23
Beam Correction.....	24
Preset Select.....	24
Preset Sync.....	24
Reset Functions.....	25
Factory Reset.....	25
Test Mode.....	25
Auto Test.....	25
Manual Test.....	25
System Information.....	26
DMX Values.....	26
50 Ch.....	26
33 Ch.....	29
Design Wheels.....	32
Gobo Wheels.....	32
Gobo Replacement.....	33
Color Wheel.....	34
Offset Mode.....	34
PAN.....	35
TILT.....	35
COLOR.....	35
GOBO.....	35
GOBO ROTATE.....	35
GOBO 2.....	35
GOBO 2 ROTATE.....	35
FOCUS1-GOBO 2.....	35
FOCUS2.....	35
FOCUS-GOBO.....	35
ZOOM.....	36
PRISM.....	36
IRIS.....	36
FROST.....	36
CYAN.....	36
MAGENTA.....	36
YELLOW.....	36
CTO.....	36
BLADE 1-1.....	36
BLADE 1-2.....	36
BLADE 2-1.....	37
BLADE 2-2.....	37
BLADE 3-1.....	37
BLADE 3-2.....	37
BLADE 4-1.....	37
BLADE 4-2.....	37
BLADE ROTATE.....	37
DIMMER 1.....	37
DIMMER 2.....	37
MAC4.....	37

## TABLE OF CONTENTS

---

MAC5 .....	38
MAC6 .....	38
Web Server .....	38
Information .....	38
Setup .....	38
Manual Test .....	38
Firmware Update .....	38
Security .....	38
<b>5. Technical Information .....</b>	<b>39</b>
Product Maintenance .....	39
<b>6. Technical Specifications .....</b>	<b>40</b>
Photometrics Chart .....	41
<b>7. Returns .....</b>	<b>42</b>
<b>8. Contact Us .....</b>	<b>43</b>

# 1. BEFORE YOU BEGIN

## What Is Included

- Maverick MK2 Profile
- Seetronic Powerkon IP65 power cord
- 2 Omega brackets with mounting hardware
- Warranty Card
- Quick Reference Guide

## Claims

Carefully unpack the product immediately and check the container to make sure all the parts are in the package and are in good condition.





If the box or the contents (the product and included accessories) appear damaged from shipping, or show signs of mishandling, notify the carrier immediately, not Chauvet. Failure to report damage to the carrier immediately may invalidate your claim. In addition, keep the box and contents for inspection.

For other issues, such as missing components or parts, damage not related to shipping, or concealed damage, file a claim with Chauvet within 7 days of delivery.

## Manual Conventions

Convention	Meaning
<b>1–512</b>	A range of values
<b>50/60</b>	A set of values of which only one can be chosen
<b>&lt;SET&gt;</b>	A button on the product's control panel
<b>Settings</b>	A product function or a menu option

## Symbols

Symbol	Meaning
	Electrical warning. Not following these instructions may cause electrical damage to the product, accessories, or the user.
	Critical installation, configuration, or operation information. Not following these instructions may make the product not work, cause damage to the product, or cause harm to the operator.
	Important installation or configuration information. The product may not function correctly if this information is not used.
	Useful information.



**Any reference to data or power connections in this manual assumes the use of Seetronic IP rated cables.**



**The term “DMX” used throughout this manual refers to the USITT DMX512-A digital data transmission protocol.**

## Safety Notes

Read all the following safety notes before working with this product. These notes contain important information about the installation, usage, and maintenance of this product.



**This product contains no user-serviceable parts. Any reference to servicing in this User Manual will only apply to properly trained, certified technicians. Do not open the housing or attempt any repairs.**



**All applicable local codes and regulations apply to proper installation of this product.**

## Personal Safety

- Avoid direct eye exposure to the light source while the product is on.
- Always disconnect the product from the power source before cleaning or replacing the fuse.
- Always connect the product to a grounded circuit to avoid the risk of electrocution.
- Do not touch the product's housing when operating because it may be very hot.

## Mounting and Rigging

- This product is for indoor use only! To prevent risk of fire or shock, do not expose this product to rain or moisture. (IP20).
- CAUTION: When transferring product from extreme temperature environments, (e.g., cold truck to warm, humid ballroom) condensation may form on the internal electronics of the product. To avoid causing a failure, allow product to fully acclimate to the surrounding environment before connecting it to power.
- Mount this product in a location with adequate ventilation, at least 20 in (50 cm) from adjacent surfaces.
- Make sure there are no flammable materials close to the product when operating.
- When hanging this product, always secure to a fastening device using a safety cable.
- Never carry the product by the power cord or any moving part.

## Power and Wiring

- Always make sure you are connecting the product to the proper voltage in accordance with the specifications in this manual or on the product's specification label.
- To eliminate unnecessary wear and improve its lifespan, during periods of non-use completely disconnect the product from power via breaker or by unplugging it.
- Never connect the product to a dimmer pack or rheostat.
- Never disconnect this product by pulling or tugging on the power cable.

## Operation

- Do not operate this product if there is damage on the housing, lenses, or cables. Have the damaged parts replaced by an authorized technician at once.
- Do not cover the ventilation slots when operating to avoid internal overheating.
- The maximum ambient temperature is 113 °F (45 °C). Do not operate the product at higher temperatures.
- In the event of a serious operation problem, stop using this product immediately!



**If your Chauvet product requires service, contact Chauvet Technical Support.**

## Expected LED Lifespan

LEDs gradually decline in brightness over time, primarily because of heat. LEDs that are arranged in clusters experience higher operating temperatures than single LEDs. For this reason, operating clustered LEDs at their fullest intensity significantly reduces the LEDs' lifespan. Under normal conditions, this lifespan is 40,000 to 50,000 hours. If extending this lifespan is vital, lower the operating temperature by improving the ventilation around the product, thus reducing the ambient temperature. In addition, limiting the overall projection intensity may extend the LEDs' lifespan..

## 2. INTRODUCTION

### Description

The Maverick MK2 Profile delivers ultimate artistic precision via its advanced 4-blade dual position rotating framing system, a stunningly bright 440W LED engine, two 6-position rotating slot and lock gobo wheels, CMY+CTO color mixing, a 7-position + white color wheel, variable frost, 3-facet prism, and a 14° to 36° zoom range. Take control with DMX, sACN, Art-Net, or W-DMX, and test with RDM. As an added feature, this outstanding moving head can receive TCP/IP in, and send out DMX simplifying cable runs.

### Features

- Fully featured 440 W LED yoke profile fixture including CMY+CTO color mixing, a four blade framing shutter system with rotation, a color wheel, 3:1 zoom, and two rotating gobo wheels
- 16-bit dimming of master dimmer for smooth control of fades
- Variable CMY + CTO color mixing system to create a wide pallet of colors
- Two rotating, indexing and interchangeable slot and lock gobo wheels
- DMX, WDMX, sACN, and Art-Net for full flexibility of control options
- RDM control over DMX for fixture reporting
- 14° to 36° zoom angle for variable beam sizes
- Iris, 3-facet prism and frost for beam control
- True 1 compatible power input
- Battery backup display with auto-rotate depending on fixture orientation



# Product Overview

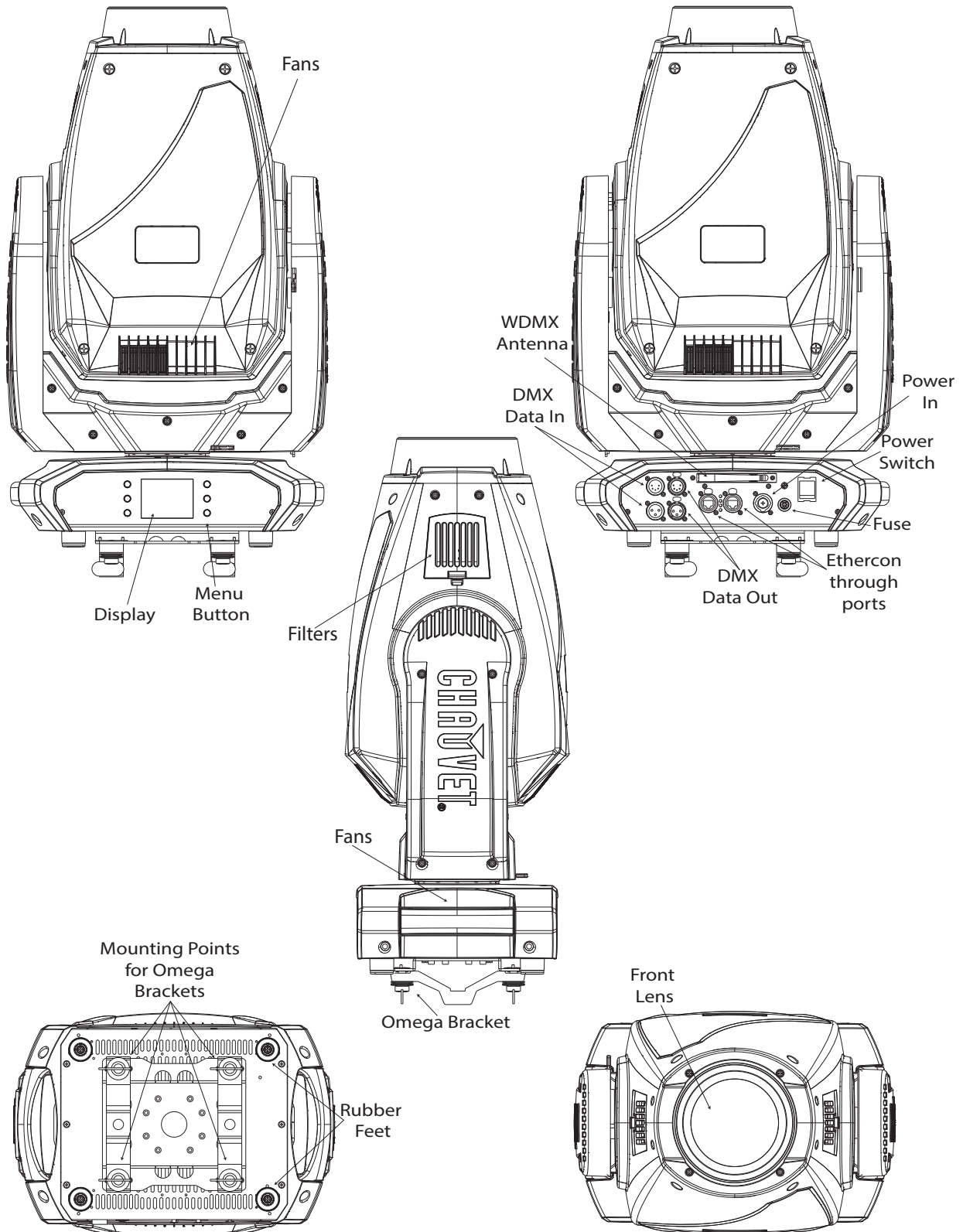

**Product Dimensions**

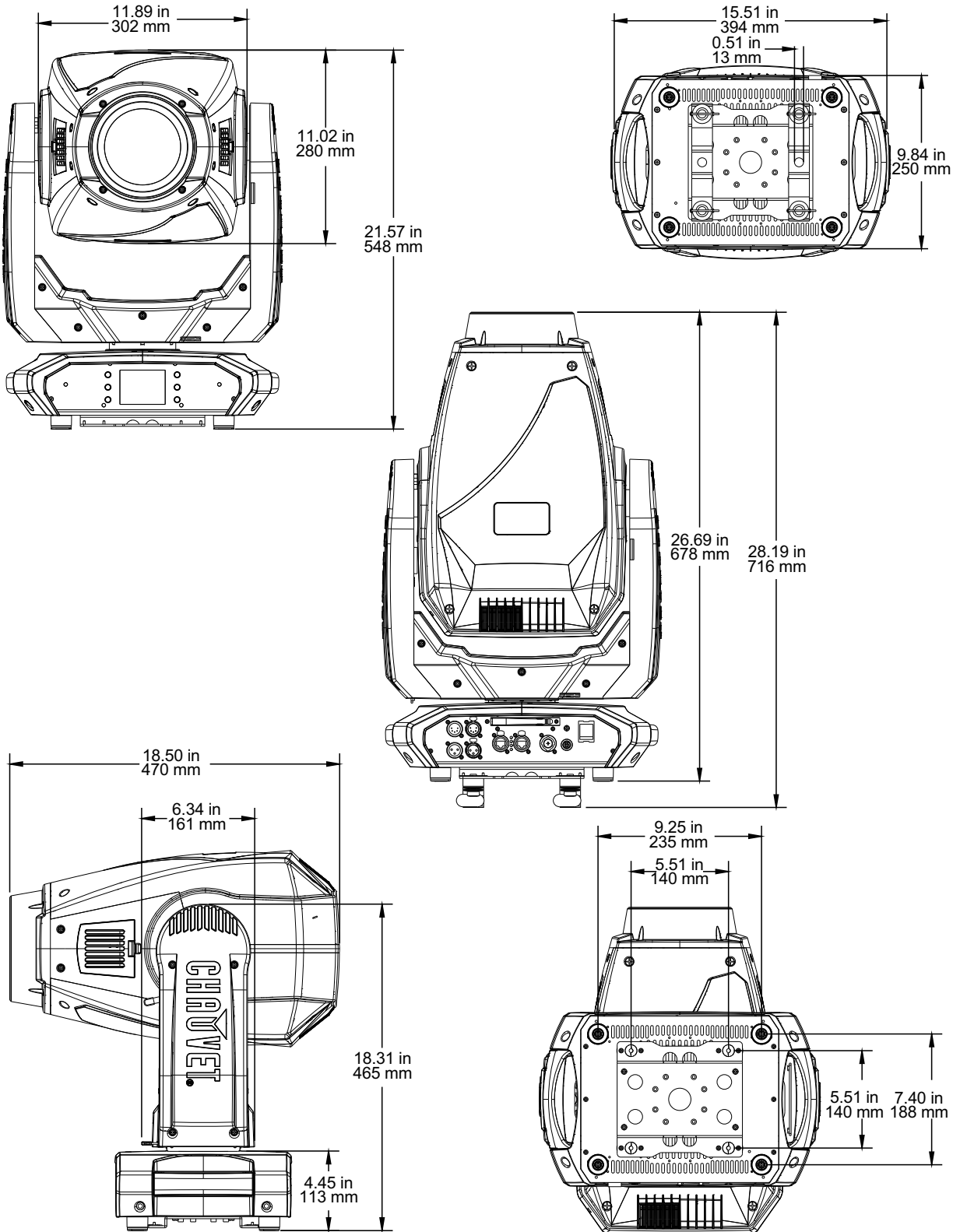

### 3. SETUP

#### AC Power

Each Maverick MK2 Profile has an auto-ranging power supply that works with an input voltage range of 100 to 240 VAC, 50/60 Hz. To determine the power requirements for each Maverick MK2 Profile, refer to the label affixed to the product. You can also refer to the Technical Specifications chart in this manual.

The listed current rating indicates the maximum current draw during normal operation. For more information, download Sizing Circuit Breakers from the Chauvet website: [www.chauvetprofessional.com](http://www.chauvetprofessional.com).



- **Always connect the product to a protected circuit (circuit breaker or fuse). Make sure the product has an appropriate electrical ground to avoid the risk of electrocution or fire.**
- **To eliminate unnecessary wear and improve its lifespan, during periods of non-use completely disconnect the product from power via breaker or by unplugging it.**



**Never connect the product to a rheostat (variable resistor) or dimmer circuit, even if the rheostat or dimmer channel serves only as a 0 to 100% switch.**

#### AC Plug

The Maverick MK2 Profile comes with a power input cord terminated with a Seetronic Powerkon A connector on one end and an Edison plug on the other end (U.S. market). If the power input cord that came with your product has no plug, or if you need to change the plug, use the table below to wire the new plug.

Connection	Wire (U.S.)	Wire (Europe)	Screw Color
AC Live	Black	Brown	Yellow or Brass
AC Neutral	White	Blue	Silver
AC Ground	Green/Yellow	Green/Yellow	Green

#### Fuse Replacement

1. Disconnect this product from the power outlet.
2. Using a flat-head screwdriver, unscrew the fuse holder cap from the housing.
3. Remove the blown fuse and replace with another fuse of the same type and rating (F 12 A, 250 V).
4. Screw the fuse holder cap back in place and reconnect power.



**Make sure to disconnect the product's power cord before replacing a blown fuse. Always replace the blown fuse with another of the same type and rating.**

## Mounting

Before mounting the product, read and follow the safety recommendations indicated in the Safety Notes. For our CHAUVET Professional line of mounting clamps, go to <http://trusst.com/products/>.

### Orientation

Always mount this product in a safe position, making sure there is adequate room for ventilation, configuration, and maintenance.

### Rigging

Chauvet recommends using the following general guidelines when mounting this product.

- Before deciding on a location for the product, make sure there is easy access to the product for maintenance and programming purposes.
- Make sure that the structure onto which you are mounting the product can support the product's weight. See the [Technical Specifications](#) for weight information.
- When mounting the product overhead, always use a safety cable. Mount the product securely to a rigging point, whether an elevated platform or a truss.
- When rigging the product onto a truss, use a mounting clamp of appropriate weight capacity.
- When power linking multiple products, mount the products close enough for power linking cables to reach.
- The bracket adjustment knobs allow for directional adjustment when aiming the product to the desired angle. Only loosen or tighten the bracket knobs manually. Using tools could damage the knobs.

### Procedure

The Maverick MK2 Profile comes with a double-bracketed yoke to which you can either attach mounting clamps for hanging or simply use as a floor stand. You must supply the mounting clamps. Make sure the clamps are capable of supporting the weight of this product. Use at least one mounting point per product. For the CHAUVET Professional line of mounting clamps, go to <http://www.trusst.com/products>.

### Mounting Diagram

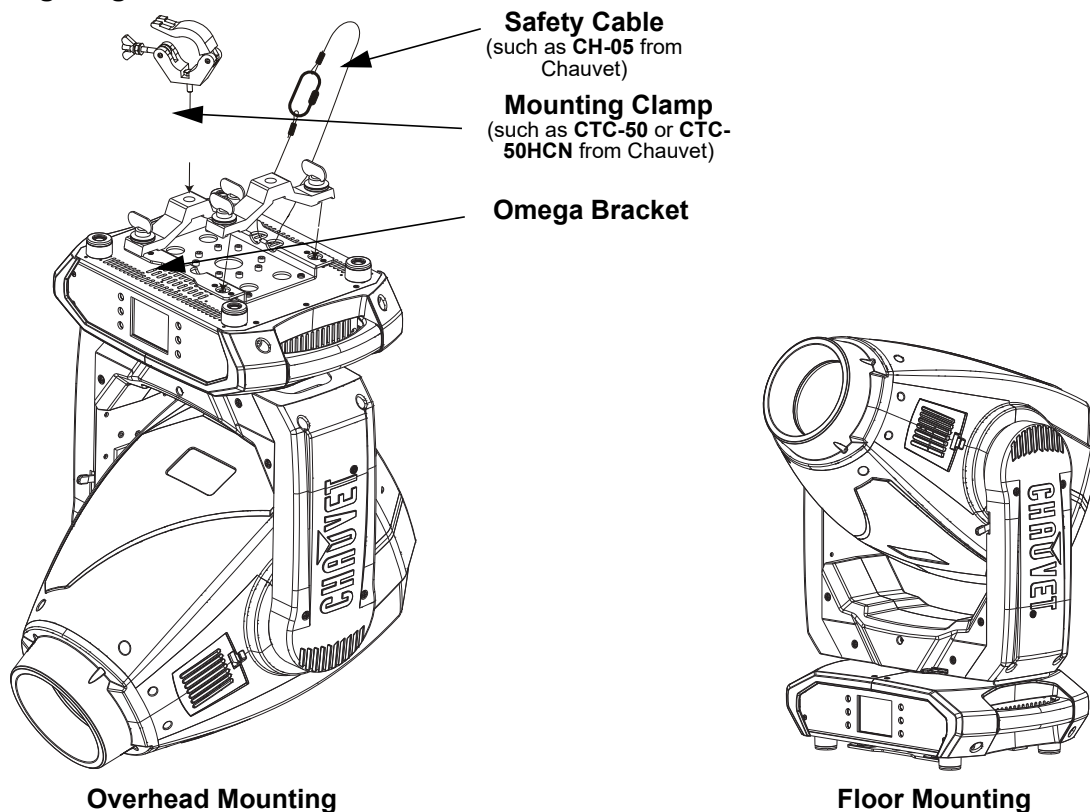

## DMX Linking

You can link the Maverick MK2 Profile to a DMX controller using a 3- or 5-pin DMX connection. If using other DMX-compatible products with this product, you can control each individually with a single DMX controller.

## DMX Personalities

The Maverick MK2 Profile uses a 3- or 5-pin DMX data connection for the 33- and 50-channel DMX personalities.

- Refer to the Introduction for a brief description of each DMX personality.
- Refer to the Operation chapter to learn how to configure the Maverick MK2 Profile to work in these personalities.
- The DMX Values section provides detailed information regarding the DMX personalities.

## Remote Device Management (RDM)

Remote Device Management, or RDM, is a standard for allowing DMX-enabled devices to communicate bi-directionally along existing DMX cabling. Check the DMX controller’s User Manual or with the manufacturer as not all DMX controllers have this capability. The Maverick MK2 Profile supports RDM protocol that allows feedback to make changes to menu map options.

## Signal Connections

The Maverick MK2 Profile can receive DMX, Art-Net™, sACN, or Kling-Net signal. The Maverick MK2 Profile has 2 Neutrik® etherCON® through ports, and 3- and 5-pin DMX in and out ports. For more information about DMX, read the DMX primer at: [https://www.chauvetprofessional.com/wp-content/uploads/2016/06/DMX\\_Primer.pdf](https://www.chauvetprofessional.com/wp-content/uploads/2016/06/DMX_Primer.pdf).

## Art-Net™ Connection

Art-Net™ is an Ethernet protocol that uses TCP/IP which transfers a large amount of DMX512 data using an Neutrik® etherCON® RJ45 connection over a large network. An Art-Net™ protocol document is available from [www.chauvetprofessional.com](http://www.chauvetprofessional.com).

Art-Net™ designed by and copyright Artistic Licence Holdings Ltd.

## sACN Connection

Also known as ANSI E1.31, streaming ACN is an Ethernet protocol that uses the layering and formatting of Architecture for Control Networks to transport DMX512 data over IP or any other ACN compatible network. ACN is maintained by the Professional Lighting and Sound Association (PLASA).

## Connection Diagram

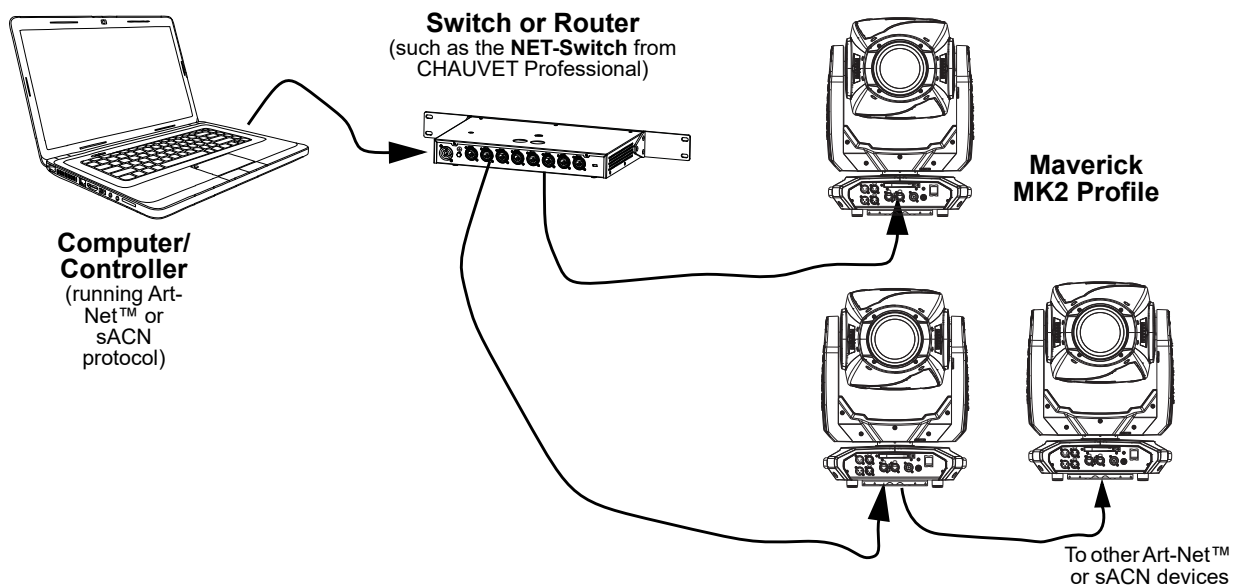







The three LED indicators in between the Ethernet through ports indicate a connection to a network and activity on that network. They do not indicate whether or not the Maverick MK2 Profile is receiving a signal from a controller.

## 4. OPERATION

The Maverick MK2 Profile has a touchscreen display as well as 6 control buttons. Navigate the menu structure by pressing the buttons, touching the images of the buttons on the sides of the display, or touching the desired menu option on the display directly. The touchscreen can be locked and calibrated through the Setup options in the menu (see [Touchscreen Calibration](#) and [Touchscreen Lock](#))

### Control Panel Operation

Button	Function
	Navigates upwards through the menu list or increases the numeric value when in a function <b>&lt;UP&gt;</b>
	Exits from the current menu or function <b>&lt;MENU&gt;</b>
	Navigates downwards through the menu list or decreases the numeric value when in a function <b>&lt;DOWN&gt;</b>
	Navigates left through the menu list <b>&lt;LEFT&gt;</b>
	Enables the currently displayed menu or sets the currently selected value into the selected function <b>&lt;ENTER&gt;</b>
	Navigates right through the menu list <b>&lt;RIGHT&gt;</b>

### Menu Map

Main Level	Programming Levels		Description
Address	000–512		Network Setting
Network Setup	IP Mode	Manual	Selection of IP mode
		DHCP	
		Static	
	Universe	000–255	Set the Universe
	Ip	002.xxx.xxx.xxx	IP setting
	SubMask	255.xxx.xxx.xxx	Subnet Mask
Personality	DMX 33CH	YES	Choose 33 Channels of DMX
		NO	
	DMX 50CH	YES	Choose 50 Channels of DMX
		NO	
Settings	ControlMode	DMX	Signal Selection
		WDMX	
		sACN	
		ArtNet	
	Pan Reverse	YES	Reverse the Pan
		NO	
	Tilt Reverse	YES	Reverse the Tilt
NO			

Main Level	Programming Levels		Description
Settings	Screen Reverse	NO	Manually or automatically reverse the screen
		YES	
		AUTO	
	Pan Angle	540	Change the Pan angle
		360	
		180	
	Tilt Angle	270	Change the Tilt angle
		180	
		90	
	BL. O. P/T Move	YES NO	Enable/disable XY blackout
	BL. O. Color Move	YES NO	Enable/disable color blackout
	BL. O. Gobo Move	YES NO	Enable/disable gobo blackout
	Calibration	YES	Turn on Calibration
		NO	
	Touchscreen Lock	YES	Lock the touchscreen
		NO	
	Lock Screen	YES	Lock the buttons and touchscreen
		NO	
	Swap X/Y	YES	Swap the pan and tilt
		NO	
	X/Y Mode	Fast	Pan and tilt speed
		Slow	
	WDMX Reset	YES	Reset the wireless DMX
		NO	
	Backlight Timer	30S	Set the backlight to turn off automatically after a chosen time
		1M	
		5M	
		ON	
	Loss of Data	Hold	Loss of data setting
		Close	
Fans	Auto	Change the fan speed mode	
	Full		
	ECO		
Legacy Dimming	Yes	Imitates Maverick MK2 Spot dimming	
	No		
Dimmer Curve	Linear	Set the dimmer curve	
	Square		
	I Square		
	Scurve		
Dimmer Speed	Smooth	Change the dimmer speed	
	Fast		
PWM Option	600	PWM selection	
	1200		
	2000		
	4000		
	6000		
	15000		
Smart Zoom	Off	Limits the zoom range for optimal focus	
	On		

Main Level	Programming Levels		Description	
Settings	Beam Correction	Off	Creates a flat field when using shutters	
		On		
	Preset Select	PRESET A	Recorded preset menu options	
		PRESET B		
		PRESET C		
	Preset Sync	NO	Allows recorded preset menu options to be transferred to other Maverick MK2 Profiles in the DMX daisy chain	
		YES		
	Reset Function	Pan/Tilt	YES/ NO	Reset individual functions to factory
		Iris/ Prism		
		Color/ CMY +Blade		
		Gobo/ Gobo Rotate		
Frost				
All				
Factory Settings	YES	Reset all functions to factory		
	NO			
Auto Test			Auto test the product	
Test	Manual Test	Pan	000 ~ 255	Individually test each function/ channel
		Pan Fine		
		Tilt		
		Tilt Fine		
		P/T Speed		
		Dimmer		
		Dimmer Fine		
		Shutter		
		Virtual Shaking		
		Cyan		
		Magenta		
		Yellow		
		CTO		
		Color		
		Gobo		
		Gobo Rotate		
		Gobo Index		
		Gobo 2		
		Gobo 2 Rotate		
		Gobo 2 Index		
		Blade 1-1		
		Blade 1-1 Fine		
		Blade 1-2		
Blade 1-2 Fine				
Blade 2-1				
Blade 2-1 Fine				



Main Level	Programming Levels		Description	
Test	Manual Test	Blade 2-2	000 ~ 255 Individually test each function/channel	
		Blade 2-2 Fine		
		Blade 3-1		
		Blade 3-1 Fine		
		Blade 3-2		
		Blade 3-2 Fine		
		Blade 4-1		
		Blade 4-1 Fine		
		Blade 4-2		
		Blade 4-2 Fine		
		Blade Rotate		
		Blade Rota Fine		
		Focus		
		Focus Fine		
		Focus Auto		
		Zoom		
		Zoom Fine		
		Prism		
		Prism Rotate		
		Iris		
Frost				
CMY Macro				
CMY Macro				
Speed				
Special Function				
Information	Fixture Information	Ver V1	Current Version	
		Running Mode DMX	Current Mode	
		DMX Address		
		Temperature	Current Temperature	
		Fixture Hours	Current active hours	
		ArtNetIp	Current IP address	
		SubMask	Current subnet mask	
	MAC Address	MAC address		
	Fan Information	Base Fan 1 Speed Base Fan 2 Speed Head Fan 1 Speed Head Fan 2 Speed		View speed setting
	Error Information	_____	Will appear on screen	
	Channel Information	Frequency	Hz	000 ~ 255 Status of individual channel
		Pan		
		Pan Fine		
		Tilt		
Tilt Fine				
P/T Speed				
Dimmer				
Dimmer Fine				

Main Level	Programming Levels		Description
Information	Channel Information	Shutter	Status of individual channel
		Virtual Shaking	
		Cyan	
		Magenta	
		Yellow	
		CTO	
		Color	
		Gobo	
		Gobo Rotate	
		Gobo Index	
		Gobo 2	
		Gobo 2 Rotate	
		Gobo 2 Index	
		Blade 1-1	
		Blade 1-1 Fine	
		Blade 1-2	
		Blade 1-2 Fine	
		Blade 2-1	
		Blade 2-1 Fine	
		Blade 2-2	
		Blade 2-2 Fine	
		Blade 3-1	
		Blade 3-1 Fine	
		Blade 3-2	
		Blade 3-2 Fine	
		Blade 4-1	
		Blade 4-1 Fine	
		Blade 4-2	
		Blade 4-2 Fine	
		Blade Rotate	
		Blade Rota Fine	
		Blade Macro	
Focus			
Focus Fine			
Focus Auto			
Zoom			
Zoom Fine			
Prism			
Prism Rotate			
Iris			
Frost			
CMY Macro			
CMY Macro			
Speed			
Special Function			

## Operating Settings Configuration

### Home Screen

The Maverick MK2 Profile has a home screen that shows the protocol mode, the IP address or DMX address, the DMX personality, and the current product temperature. To see the home screen, press **<MENU>** repeatedly until it appears on the display.

### Start Address

To set the starting address, set the Control Mode and then follow the instructions below:

1. Press **<MENU>** repeatedly until the Home Screen shows on the display. Press **<ENTER>**.
2. Use **<UP>**, **<DOWN>**, **<LEFT>**, or **<RIGHT>** to select **Start Address**, or touch the display where it says **Start Address**.
3. If using the buttons instead of the touchscreen, press **<ENTER>**.
4. Enter the starting address (**001–512**) with one of the following methods:
  - Type the address number using the number pad that shows on the touchscreen display.
  - Using the buttons (or the button icons on the sides of the display),
    - a. Use **<LEFT>** or **<RIGHT>** to select the digit to be altered.
    - b. Use **<UP>** or **<DOWN>** to increase or decrease the number value of that digit.
    - c. Repeat until the address is set as desired.
5. Press **<ENTER>**.

### Network Setup



**The universe of the TCP/IP protocol will be the universe of the DMX function.**

### IP Mode

The IP address of the Maverick MK2 Profile can be set manually, by the network, or to a pre-set static address specific to each product. To set the IP Mode, follow the instructions below:

1. Press **<MENU>** repeatedly until the Home Screen shows on the display. Press **<ENTER>**.
2. Use **<UP>**, **<DOWN>**, **<LEFT>**, or **<RIGHT>** to select **Network Setup**, or touch the display where it says **Network Setup**.
3. If using the buttons instead of the touchscreen, press **<ENTER>**.
4. Use **<UP>** or **<DOWN>** to select **IP Mode**, or touch the display where it says **IP Mode**.
5. If using the buttons instead of the touchscreen, press **<ENTER>**.
6. Use **<UP>**, **<DOWN>**, **<LEFT>**, or **<RIGHT>** to select from:
  - **Manual** (set the IP address with the control panel),
  - **DHCP** (the network sets the IP address),or
  - **Static** (a pre-set address specific to each product), or touch the display where it says the desired mode.
7. Press **<ENTER>**.

## Universe

The Universe must be assigned through the product menu. To set the Universe do the following:

1. Press **<MENU>** repeatedly until the Home Screen shows on the display. Press **<ENTER>**.
2. Use **<UP>**, **<DOWN>**, **<LEFT>**, or **<RIGHT>** to select **Network Setup**, or touch the display where it says **Network Setup**.
3. If using the buttons instead of the touchscreen, press **<ENTER>**.
4. Use **<UP>** or **<DOWN>** to select **Universe**, or touch the display where it says **Universe**.
5. If using the buttons instead of the touchscreen, press **<ENTER>**.
6. Enter the universe address (**0–254** for **ArtNet**, **0–255** for **sACN**) with one of the following methods:
  - Type the universe number using the number pad that shows on the touchscreen display.  
or
  - Using the buttons (or the button icons on the sides of the display),
    - a. Use **<LEFT>** or **<RIGHT>** to select the digit to be altered.
    - b. Use **<UP>** or **<DOWN>** to increase or decrease the number value of that digit.
    - c. Repeat until the universe or subnet is set as desired.

## Artnet IP Address

To set the IP address, do the following:

1. Press **<MENU>** repeatedly until the Home Screen shows on the display. Press **<ENTER>**.
2. Use **<UP>**, **<DOWN>**, **<LEFT>**, or **<RIGHT>** to select **Network Setup**, or touch the display where it says **Network Setup**.
3. If using the buttons instead of the touchscreen, press **<ENTER>**.
4. Use **<UP>** or **<DOWN>** to select **IP**, or touch the display where it says **IP**.
5. If using the buttons instead of the touchscreen, press **<ENTER>**.
6. Set the IP address (from **000.000.000.000** to **255.255.255.255**) with one of the following methods:
  - Through the touchscreen:
    - a. Touch the display where it shows the byte (set of three numbers) to be changed. Use the number pad on the display to enter the desired number.
    - b. Use the number pad on the display to enter the desired number.
    - c. Repeat until the IP address is set as desired.
  - With the buttons:
    - a. Use **<LEFT>** or **<RIGHT>** to select the byte (set of three numbers) to be changed).
    - b. Use **<UP>** or **<DOWN>** to increase or decrease the value.
    - c. Repeat until the IP address is set as desired
7. Press **<ENTER>**.

## Subnet Mask

To set the Subnet Mask, do the following:

1. Press **<MENU>** repeatedly until the Home Screen shows on the display. Press **<ENTER>**
2. Use **<UP>**, **<DOWN>**, **<LEFT>**, or **<RIGHT>** to select **Network Setup**, or touch the display where it says **Network Setup**.
3. If using the buttons instead of the touchscreen, press **<ENTER>**.
4. Use **<UP>** or **<DOWN>** to select **SubMask**, or touch the display where it says **SubMask**.
5. If using the buttons instead of the touchscreen, press **<ENTER>**
6. Set the Subnet Mask (from **000.000.000.000** to **255.255.255.255**) with one of the following methods.
  - Through the touchscreen:
    - a. Touch the display where it shows the byte (set of three numbers) to be changed. Use the number pad on the display to enter the desired number.
    - b. Use the number pad on the display to enter the desired number.
    - c. Repeat until the IP address is set as desired.
  - With the buttons:
    - a. Use **<LEFT>** or **<RIGHT>** to select the byte (set of three numbers to be changed).
    - b. Use **<UP>** or **<DOWN>** to increase or decrease the value.
    - c. Repeat until the IP address is set as desired
7. Press **<ENTER>**.



In DHCP or Static IP Mode, the IP and SubMask menu settings have no effect on the product.

## Personality

To set which DMX personality to use, do the following:

1. Press **<MENU>** repeatedly until the Home Screen shows on the display. Press **<ENTER>**.
2. Use **<UP>**, **<DOWN>**, **<LEFT>**, or **<RIGHT>** to select **Personality**, or touch the display where it says **Personality**
3. If using the buttons instead of the touchscreen, press **<ENTER>**.
4. Use **<UP>**, **<DOWN>**, **<LEFT>**, or **<RIGHT>** to select **DMX 22CH** or **DMX 29CH**, or touch the display where it says the desired option.
5. If using the buttons instead of the touchscreen, press **<ENTER>**.
6. Use **<UP>**, **<DOWN>**, **<LEFT>**, or **<RIGHT>** to select **NO** (cancel) or **YES** (confirm) or touch the display where it says the desired option.
7. Press **<ENTER>**.

## Settings

To reach the **Settings** menu, follow the instructions below:

1. Press **<MENU>** repeatedly until the Home Screen shows on the display. Press **<ENTER>**.
2. Use **<UP>**, **<DOWN>**, **<LEFT>**, or **<RIGHT>** to select **Settings**, or touch the display where it says **Settings**.
3. If using the buttons instead of the touchscreen, press **<ENTER>**.

## Control Mode

The Maverick MK2 Profile can be set to respond to DMX, WDMX, Art-Net™ or sACN. The protocol configuration must be set for the product to respond correctly to the controller(s). See the Menu Map for more information.

To configure the protocol for the Maverick MK2 Profile, follow the instructions below:

1. Navigate to the **Settings** menu.
2. Use **<UP>** or **<DOWN>** to select **Control Mode**, or touch the display where it says **Control Mode**.
3. If using the buttons instead of the touchscreen, press **<ENTER>**.
4. Use **<UP>**, **<DOWN>**, **<LEFT>**, or **<RIGHT>** to select **DMX**, **WDMX**, **sACN**, **ArtNet.**, or touch the display where it says the desired option
5. Press **<ENTER>**.



**For WDMX control, ensure the antenna is raised and there are no obstructions between the controller and the product. See WDMX Reset for troubleshooting information.**

## Pan/Tilt Orientation

To set whether the pan or tilt orientation is normal or inverted:

1. Navigate to the Settings menu
2. Use **<UP>** or **<DOWN>** to select **Pan Reverse** or **Tilt Reverse**, or touch the display where it says the desired setting.
3. If using the buttons instead of the touchscreen, press **<ENTER>**.
4. Use **<UP>**, **<DOWN>**, **<LEFT>**, or **<RIGHT>** to select **NO** (normal orientation) or **YES** (inverted orientation), or touch the display where it says the desired option.
5. Press **<ENTER>**.

## Display Orientation

To set which way the display faces, do the following:

1. Navigate to the **Settings** menu.
2. Use **<UP>** or **<DOWN>** to select **Screen Reverse**, or touch the display where it says **Screen Reverse**.
3. If using the buttons instead of the touchscreen, press **<ENTER>**.
4. Use **<UP>**, **<DOWN>**, **<LEFT>**, or **<RIGHT>** to select **NO** (display is normal), **YES** (display is inverted), or **AUTO** (the display automatically detects which way the product is facing and orients itself accordingly), or touch the display where it says the desired option.
5. Press **<ENTER>**

## Pan/Tilt Angle Range

To set the range of motion the pan or tilt is permitted:

1. Navigate to the **Settings** menu.
2. Use **<UP>** or **<DOWN>** to select **Pan Angle** or **Tilt Angle**, or touch the display where it says the desired setting.
3. If using the buttons instead of the touchscreen, press **<ENTER>**.
4. Use **<UP>**, **<DOWN>**, **<LEFT>**, or **<RIGHT>** to select **540** (540°), **360** or **270** (360° or 270° for pan or tilt respectively), **180** (180°), or **90** (90°) or touch the display where it says the desired option.
5. Press **<ENTER>**

## Blackout on Pan/Tilt Movement

To set whether the product will black out during pan or tilt movement, follow the instructions below:

1. Navigate to the **Settings** menu.
2. Use **<UP>** or **<DOWN>** to select **BL. O. P/T Move**, or touch the display where it says **BL. O. P/T Move**.
3. If using the buttons instead of the touchscreen, press **<ENTER>**.
4. Use **<UP>**, **<DOWN>**, **<LEFT>**, or **<RIGHT>** to select **NO** (do not black out) or **YES** (black out during movement), or touch the display where it says the desired option.
5. Press **<ENTER>**.

## Blackout on Color Movement

To set whether the product will black out during color movement, follow the instructions below:

1. Navigate to the **Settings** menu
2. Use **<UP>** or **<DOWN>** to select **BL. O. Color Move**, or touch the display where it says **BL. O. Color Move**.
3. If using the buttons instead of the touchscreen, press **<ENTER>**.
4. Use **<UP>**, **<DOWN>**, **<LEFT>**, or **<RIGHT>** to select **NO** (do not black out) or **YES** (black out during movement), or touch the display where it says the desired option
5. Press **<ENTER>**.

## Blackout on Gobo Movement

To set whether the product will black out during color movement, follow the instructions below:

1. Navigate to the **Settings** menu
2. Use **<UP>** or **<DOWN>** to select **BL. O. Gobo Move**, or touch the display where it says **BL. O. Gobo Move**.
3. If using the buttons instead of the touchscreen, press **<ENTER>**.
4. Use **<UP>**, **<DOWN>**, **<LEFT>**, or **<RIGHT>** to select **NO** (do not black out) or **YES** (black out during movement), or touch the display where it says the desired option
5. Press **<ENTER>**.

## Touchscreen Calibration

If the touchscreen is not responding correctly, it may need to be calibrated. To do so:

1. Navigate to the **Settings** menu.
2. Use **<UP>** or **<DOWN>** to select **Calibration**, or touch the display where it says **Calibration**.
3. If using the buttons instead of the touchscreen, press **<ENTER>**.
4. Use **<UP>**, **<DOWN>**, **<LEFT>**, or **<RIGHT>** to select **NO** (do not calibrate) or **YES** (calibrate), or touch the display where it says the desired option.
5. Press **<ENTER>**.
6. Follow the instructions, touching the points as they appear on the display.

## Touchscreen Lock

To lock or unlock the touchscreen control panel, do the following:

1. Navigate to the **Settings** menu.
2. Use **<UP>** or **<DOWN>** to select **Touchscreen Lock**, or touch the display where it says **Touchscreen Lock**.
3. If using the buttons instead of the touchscreen, press **<ENTER>**.
4. Use **<UP>**, **<DOWN>**, **<LEFT>**, or **<RIGHT>** to select **NO** (display will respond to touch) or **YES** (display will not respond to touch), or touch the display where it says the desired option.
5. Press **<ENTER>**.

## Lock the Screen

To lock the touchscreen control panel and menu buttons, do the following:

1. Navigate to the **Settings** menu.
2. Use **<UP>** or **<DOWN>** to select **Lock Screen**, or touch the display where it says **Lock Screen**.
3. If using the buttons instead of the touchscreen, press **<ENTER>**.
4. Use **<UP>**, **<DOWN>**, **<LEFT>**, or **<RIGHT>** to select **NO** (display will respond to touch or buttons) or **YES** (display will not respond to touch or buttons), or touch the display where it says the desired option.
5. Press **<ENTER>**.

To unlock the touchscreen and menu buttons, do the following:

1. Touch the display touchscreen anywhere or push any menu button.
2. Enter the passcode (**0920**) using the touchscreen or buttons.

## Swap Pan and Tilt

To switch the pan and tilt functions so that what normally controls the pan controls the tilt and what normally controls the tilt controls the pan, follow the instructions below:

1. Navigate to the **Settings** menu.
2. Use **<UP>** or **<DOWN>** to select **Swap XY**, or touch the display where it says **Swap XY**.
3. If using the buttons instead of the touchscreen, press **<ENTER>**.
4. Use **<UP>**, **<DOWN>**, **<LEFT>**, or **<RIGHT>** to select **NO** (normal pan and tilt) or **YES** (pan controls tilt, tilt controls pan), or touch the display where it says the desired option.
5. Press **<ENTER>**.

## Pan/Tilt Speed

To set the maximum speed of the pan and tilt:

1. Navigate to the **Settings** menu.
2. Use **<UP>** or **<DOWN>** to select **XY Mode**, or touch the display where it says **XY Mode**.
3. If using the buttons instead of the touchscreen, press **<ENTER>**.
4. Use **<UP>**, **<DOWN>**, **<LEFT>**, or **<RIGHT>** to select **Slow** or **Fast**, or touch the display where it says the desired option.
5. Press **<ENTER>**.

## WDMX Reset

To reset the WDMX connection from the Maverick MK2 Profile, do the following:

1. Navigate to the **Settings** menu.
2. Use **<UP>** or **<DOWN>** to select **WDMX Reset**, or touch the display where it says **WDMX Reset**.
3. If using the buttons instead of the touchscreen, press **<ENTER>**.
4. Use **<UP>**, **<DOWN>**, **<LEFT>**, or **<RIGHT>** to select **NO** (do not reset connection), **YES** (reset the connection), or touch the display where it says the desired option.
5. Press **<ENTER>**.



Once a WDMX receiver has been linked to a specific WDMX transmitter, it will remain linked to that specific transmitter until it is linked to a different one.

## Backlight Timer

To set the amount of time after inactivity before the display backlight turns off:

1. Navigate to the **Settings** menu.
2. Use **<UP>** or **<DOWN>** to select **Backlight Timer**, or touch the display where it says **Backlight Timer**.
3. If using the buttons instead of the touchscreen, press **<ENTER>**.
4. Use **<UP>**, **<DOWN>**, **<LEFT>**, or **<RIGHT>** to select **30S** (after 30 seconds of inactivity), **1M** (after 1 minute of inactivity), **5M** (after 5 minutes of inactivity), or **30M** (after 30 minutes of inactivity), or touch the display where it says the desired option.
5. Press **<ENTER>**.



## Loss of Data

In case of an input signal being lost in any way, the Maverick MK2 Profile will respond in one of two ways. The product will either hold the last signal received, or black out all LED output.

To set which way the product responds, follow the instructions below:

1. Navigate to the **Settings** menu.
2. Use **<UP>** or **<DOWN>** to select **Loss of Data**, or touch the display where it says **Loss of Data**.
3. If using the buttons instead of the touchscreen, press **<ENTER>**.
4. Use **<UP>**, **<DOWN>**, **<LEFT>**, or **<RIGHT>** to select **Hold** (hold last signal received) or **Close** (black out all LED output), or touch the display where it says the desired option.
5. Press **<ENTER>**.

## Fan Speed

To set the speed of the fans, do the following:

1. Navigate to the **Settings** menu.
2. Use **<UP>** or **<DOWN>** to select **Fans**, or touch the display where it says **Fans**.
3. If using the buttons instead of the touchscreen, press **<ENTER>**.
4. Use **<UP>**, **<DOWN>**, **<LEFT>**, or **<RIGHT>** to select **Auto** (fan speed set according to product temperature), **Full** (maximum speed), or **ECO** (quiet fans mode), or touch the display where it says the desired option.
5. Press **<ENTER>**.

## Dimmer Curve

To set the dimmer curve, follow the instructions below:

1. Navigate to the **Settings** menu.
2. Use **<UP>** or **<DOWN>** to select **Dimmer Curve**, or touch the display where it says **Dimmer Curve**.
3. If using the buttons instead of the touchscreen, press **<ENTER>**.
4. Use **<UP>**, **<DOWN>**, **<LEFT>**, or **<RIGHT>** to select **Linear**, **Square**, **I Squa**, or **SCurve**, or touch the display where it says the desired option.
5. Press **<ENTER>**.

## Dimmer Speed

To set the dimmer speed, do the following:

1. Navigate to the **Settings** menu.
2. Use **<UP>** or **<DOWN>** to select **Dimmer Speed**, or touch the display where it says **Dimmer Speed**.
3. If using the buttons instead of the touchscreen, press **<ENTER>**.
4. Use **<UP>**, **<DOWN>**, **<LEFT>**, or **<RIGHT>** to select **Smooth** or **Fast**, or touch the display where it says the desired option.
5. Press **<ENTER>**.

## Pulse Width Modulation

To set the PWM frequency, follow the instructions below:

1. Navigate to the **Settings** menu.
2. Use **<UP>** or **<DOWN>** to select **PWM Option**, or touch the display where it says **PWM Option**.
3. If using the buttons instead of the touchscreen, press **<ENTER>**.
4. Use **<UP>**, **<DOWN>**, **<LEFT>**, or **<RIGHT>** to select the PWM frequency, from **600Hz**, **1200Hz**, **2000Hz**, **4000Hz**, **6000Hz**, or **15000Hz**, or touch the display where it says the desired option.
5. Press **<ENTER>**.

## Smart Zoom

To set the zoom range to optimal focus, follow the instructions below:

1. Navigate to the **Settings** menu.
2. Use **<UP>** or **<DOWN>** to select **Smart Zoom**, or touch the display where it says **Smart Zoom**.
3. If using the buttons instead of the touchscreen, press **<ENTER>**.
4. Select **YES** or touch the display where it says the desired option.
5. Press **<ENTER>**.

## Beam Correction

In order to achieve a flat field while using the shutters, use the beam correction feature. Follow the instructions below:

1. Navigate to the [Settings](#) menu.
2. Use **<UP>** or **<DOWN>** to select **Beam Correction**, or touch the display where it says **Beam Correction**.
3. If using the buttons instead of the touchscreen, press **<ENTER>**.
4. Select **YES** or touch the display where it says the desired option.
5. Press **<ENTER>**

## Preset Select

This option saves 3 different preset menu option configurations. To record and set these presets follow the instructions below:

1. Navigate to the [Settings](#) menu.
2. Use **<UP>** or **<DOWN>** to select **Preset Select**, or touch the display where it says **Preset Select**.
3. If using the buttons instead of the touchscreen, press **<ENTER>**.
4. Use **<UP>**, **<DOWN>**, **<LEFT>**, or **<RIGHT>** to select the presets, from **PRESET A**, **PRESET B**, or **PRESET C**, or touch the display where it says the desired option.
5. Press **<ENTER>**.
6. The product will reset. Any changes made to the menu options will be saved to this preset.



- Default is **PRESET A**. If you make changes inside **PRESET A**, those changes are saved to **PRESET A** without having to do anything.
- To create a new preset, highlight and select **PRESET SELECT**. Highlight **PRESET B** or **PRESET C** and press **<ENTER>**. When you make that selection, the product will reset automatically. Go back and make the changes you need to make in the menu. This will automatically save to the preset you are in.

## Preset Sync

To sync all menu presets to other Maverick MK2 Profiles, follow the instructions below:

1. Connect all Maverick MK2 Profiles via DMX cable.
2. Navigate to the [Settings](#) menu.
3. Use **<UP>** or **<DOWN>** to select **Preset Sync**, or touch the display where it says **Preset Sync**.
4. If using the buttons instead of the touchscreen, press **<ENTER>**.
5. Select **YES** or touch the display where it says the desired option.
6. Press **<ENTER>**.



- To sync other Maverick MK2 Profiles, you connect those products by a DMX cable.
- The product can be in any control mode **except WDMX**. ArtNet, DMX, sACN are all acceptable.
- All menu options are transferred, including the DMX address. Only the IP address is not affected in the other products.



**Only connect Maverick MK2 Profiles.**

## Reset Functions

To reset the pan, tilt, or all functions as if from startup:

1. Navigate to the **Settings** menu.
2. Use **<UP>** or **<DOWN>** to select **Reset Function**, or touch the display where it says **Reset Function**.
3. If using the buttons instead of the touchscreen, press **<ENTER>**.
4. Use **<UP>**, **<DOWN>**, **<LEFT>**, or **<RIGHT>** to select **Pan/Tilt, Iris/Prism, Color/CMY+ Blade, Gobo/Gobo Rotate, Frost** or **All**, or touch the display where it says the desired option.
5. Press **<ENTER>**.

## Factory Reset

To restore the Maverick MK2 Profile to factory default settings, do the following:

1. Navigate to the **Settings** menu.
2. Use **<UP>** or **<DOWN>** to select **Factory Settings**, or touch the display where it says **Factory Settings**.
3. If using the buttons instead of the touchscreen, press **<ENTER>**.
4. Use **<UP>**, **<DOWN>**, **<LEFT>**, or **<RIGHT>** to select **NO** (do not reset) or **YES** (reset to factory settings), or touch the display where it says the desired option.
5. Press **<ENTER>**.

## Test Mode

### Auto Test

To perform an auto test of the Maverick MK2 Profile functions, follow the instructions below:

1. Press **<MENU>** repeatedly until the Home Screen shows on the display. Press **<ENTER>**.
2. Use **<UP>**, **<DOWN>**, **<LEFT>**, or **<RIGHT>** to select **Test**, or touch the display where it says **Test**.
3. If using the buttons instead of the touchscreen, press **<ENTER>**.
4. Use **<UP>** or **<DOWN>** to select **Auto test**, or touch the display where it says **Auto test**.
5. Press **<ENTER>**.

### Manual Test

To test the functions of the product manually, do the following:

1. Press **<MENU>** repeatedly until the Home Screen shows on the display. Press **<ENTER>**.
2. Use **<UP>**, **<DOWN>**, **<LEFT>**, or **<RIGHT>** to select **Test**, or touch the display where it says **Test**.
3. If using the buttons instead of the touchscreen, press **<ENTER>**.
4. Use **<UP>** or **<DOWN>** to select **Manual test**, or touch the display where it says **Manual test**.
5. If using the buttons instead of the touchscreen, press **<ENTER>**.
6. Use **<UP>** or **<DOWN>** to select the function to test, from **Pan, Pan Fine, Tilt, Tilt Fine, P/T Speed, Dimmer, Dimmer Fine, Shutter, Virtual Shaking, Cyan, Magenta, Yellow, CTO, Color, Gobo, Gobo Rotate, Gobo Index, Gobo 2, Gobo 2 Rotate, Gobo 2 Index, Blade 1-1, Blade 1-1 Fine, Blade 1-2, Blade 1-2 Fine, Blade 2-1, Blade 2-1 Fine, Blade 2-2, Blade 2-2 Fine, Blade 3-1, Blade 3-1 Fine, Blade 3-2, Blade 3-2 Fine, Blade 4-1, Blade 4-1 Fine, Blade 4-2, Blade 4-2 Fine, Blade Rotate, Blade Rota Fine, Blade Macro, Focus, Focus Fine, Focus Auto, Zoom, Zoom Fine, Prism, Prism Rotate, Iris, Frost, CMY Macro, CMY Macro Speed, or Special Function**, or touch the display where it says the desired function
7. If using the buttons instead of the touchscreen, press **<ENTER>**.
8. Change the value of the tested function with one of the following methods:
  - Type the desired value using the number pad that shows on the touchscreen display.
  - or
  - Use **<UP>**, **<RIGHT>**, **<DOWN>**, or **<LEFT>** to increase or decrease the value.
9. Press **<ENTER>**.

## System Information

All information about the current status of the Maverick MK2 Profile is available through the product's **Sys Info** menu. To view this information, follow the instructions below:

1. Press **<MENU>** repeatedly until the Home Screen shows on the display. Press **<ENTER>**.
2. Use **<UP>**, **<DOWN>**, **<LEFT>**, or **<RIGHT>** to select **Information**, or touch the display where it says **Test**.
3. If using the buttons instead of the touchscreen, press **<ENTER>**.
4. Use **<UP>** or **<DOWN>** to select **Fixture Information** (shows firmware version, running mode, starting address, etc.), **Fan Information** (shows speed of the head fans in rpm), **Error Information** (shows any errors or No Error!), or **Channel Information** (shows the current value of all signal input channels), or touch the display where it says the desired option.
5. Press **<ENTER>**.
6. Use **<UP>** or **<DOWN>** to scroll through the information.

## DMX Values

### 50 Ch

Channel	Function	Value	Percent/Setting
1	Pan	000 ⇄ 255	0-100%
2	Fine Pan	000 ⇄ 255	Fine control (16-bit)
3	Tilt	000 ⇄ 255	0-100%
4	Fine Tilt	000 ⇄ 255	Fine control (16-bit)
5	Pan/Tilt Speed	000 ⇄ 255	0-100%
6	Dimmer	000 ⇄ 255	0-100%
7	Fine Dimmer	000 ⇄ 255	Fine control (16-bit)
8	Shutter	000 ⇄ 003	Closed
		004 ⇄ 007	Open
		008 ⇄ 076	Slow to fast
		077 ⇄ 145	Pulse effect from slow to fast
		146 ⇄ 215	Random effect from slow to fast
		216 ⇄ 255	Open
9	Virtual Strobe	000 ⇄ 001	No function
		002 ⇄ 128	Shaking strobe, slow to fast
		129 ⇄ 255	Fade in/out, slow to fast
10	Cyan	000 ⇄ 255	0-100%
11	Magenta	000 ⇄ 255	0-100%
12	Yellow	000 ⇄ 255	0-100%
13	CTO	000 ⇄ 255	0-100%
14	Color Wheel	000 ⇄ 006	Open
		007 ⇄ 013	Red
		014 ⇄ 020	Orange
		021 ⇄ 027	Green
		028 ⇄ 034	Blue
		035 ⇄ 041	Magenta
		042 ⇄ 048	CTO
		049 ⇄ 059	UV
		060 ⇄ 187	Split colors
		188 ⇄ 219	Clockwise color scroll, fast to slow
		220 ⇄ 223	Stop
		224 ⇄ 255	Counter-clockwise color scroll, slow to fast

Channel	Function	Value	Percent/Setting
15	Gobo Wheel 1	000 ⇄ 008	Open
		009 ⇄ 017	Gobo 1 (Circuits)
		018 ⇄ 026	Gobo 2 (Ring of Rings)
		027 ⇄ 035	Gobo 3 (Checker Vortex)
		036 ⇄ 044	Gobo 4 (Triangle)
		045 ⇄ 053	Gobo 5 (Star Field)
		054 ⇄ 063	Gobo 6 (Lenticular Glass)
		064 ⇄ 073	Gobo 6 Shaking
		074 ⇄ 082	Gobo 5 Shaking
		083 ⇄ 091	Gobo 4 Shaking
		092 ⇄ 100	Gobo 3 Shaking
		101 ⇄ 109	Gobo 2 Shaking
		110 ⇄ 118	Gobo 1 Shaking
		119 ⇄ 127	Open
		128 ⇄ 191	Clockwise gobo scroll, slow to fast
192 ⇄ 255	Counter-clockwise gobo scroll, slow to fast		
16	Gobo 1 Rotate	000 ⇄ 063	Rotating gobo index
		064 ⇄ 145	Clockwise rotating, fast to slow
		146 ⇄ 149	Stop
		150 ⇄ 231	Counter-clockwise rotating, slow to fast
		232 ⇄ 255	Bounce effect
17	Gobo Wheel 1 Index Fine	000 ⇄ 255	Fine control (16-bit)
18	Gobo Wheel 2	000 ⇄ 008	Open
		009 ⇄ 017	Gobo 1 (Spiral)
		018 ⇄ 026	Gobo 2 (Dot Chiclets)
		027 ⇄ 035	Gobo 3 (Splat Breakup)
		036 ⇄ 044	Gobo 4 (Wavy Bar)
		045 ⇄ 053	Gobo 5 (Shower Glass)
		054 ⇄ 063	Gobo 6 (Lenticular Glass)
		064 ⇄ 073	Gobo 6 Shaking
		074 ⇄ 082	Gobo 5 Shaking
		083 ⇄ 091	Gobo 4 Shaking
		092 ⇄ 100	Gobo 3 Shaking
		101 ⇄ 109	Gobo 2 Shaking
		110 ⇄ 118	Gobo 1 Shaking
		119 ⇄ 127	Open
		128 ⇄ 191	Clockwise gobo scroll, slow to fast
192 ⇄ 255	Counter-clockwise gobo scroll, slow to fast		
19	Gobo 2 Rotate	000 ⇄ 063	Rotating gobo index
		064 ⇄ 145	Clockwise rotating, fast to slow
		146 ⇄ 149	Stop
		150 ⇄ 231	Counter-clockwise rotating, slow to fast
		232 ⇄ 255	Bounce effect
20	Gobo Wheel 2 Index Fine	000 ⇄ 255	Fine control (16-bit)
21	Blade 1a	000 ⇄ 255	0-100%
22	Blade 1a Fine	000 ⇄ 255	Fine control (16-bit)
23	Blade 1b	000 ⇄ 255	0-100%
24	Blade 1b Fine	000 ⇄ 255	Fine control (16-bit)
25	Blade 2a	000 ⇄ 255	0-100%
26	Blade 2a Fine	000 ⇄ 255	Fine control (16-bit)
27	Blade 2b	000 ⇄ 255	0-100%
28	Blade 2b Fine	000 ⇄ 255	Fine control (16-bit)
29	Blade 3a	000 ⇄ 255	0-100%
30	Blade 3a Fine	000 ⇄ 255	Fine control (16-bit)

Channel	Function	Value	Percent/Setting
31	Blade 3b	000 ⇄ 255	0-100%
32	Blade 3b Fine	000 ⇄ 255	Fine control (16-bit)
33	Blade 4a	000 ⇄ 255	0-100%
34	Blade 4a Fine	000 ⇄ 255	Fine control (16-bit)
35	Blade 4b	000 ⇄ 255	0-100%
36	Blade 4b Fine	000 ⇄ 255	Fine control (16-bit)
37	Frame Rotate	000 ⇄ 255	0-100%
38	Frame Fine Rotate	000 ⇄ 255	Fine control (16-bit)
39	Focus	000 ⇄ 255	0-100%
40	Fine Focus	000 ⇄ 255	Fine control (16-bit)
41	Auto Focus	000 ⇄ 010	No function
		011 ⇄ 030	0-5 m
		031 ⇄ 050	6 m
		051 ⇄ 070	7 m
		071 ⇄ 090	8 m
		091 ⇄ 110	9 m
		111 ⇄ 130	10 m
		131 ⇄ 150	12.5 m
		151 ⇄ 170	15 m
		171 ⇄ 190	17.5 m
191 ⇄ 210	20~60 m		
211 ⇄ 255	Auto-detect distance		
42	Zoom	000 ⇄ 255	Narrow-wide
43	Fine Zoom	000 ⇄ 255	Fine control (16-bit)
44	Prism	000 ⇄ 004	No function
		005 ⇄ 255	Prism Effect
45	Prism Rotate	000 ⇄ 127	Rotating position
		128 ⇄ 189	Clockwise rotating, fast to slow
		190 ⇄ 193	Stop
		194 ⇄ 255	Counter-clockwise rotating, slow to fast
46	Iris	000 ⇄ 063	Big to small
		064 ⇄ 127	Auto change, slow to fast
		128 ⇄ 191	Slow zoom out, fast zoom in (slow to fast)
		192 ⇄ 255	Slow zoom in, fast zoom out (slow to fast)
47	Frost	000 ⇄ 255	0-100%
48	CMY Macro	000 ⇄ 009	No function
		010 ⇄ 255	CMY macro
49	CMY Macro Speed	000 ⇄ 255	100%-0

Channel	Function	Value	Percent/Setting
50	Control	000 ⇄ 007	No function
		008 ⇄ 015	XY blackout
		016 ⇄ 023	C blackout
		024 ⇄ 031	G blackout
		032 ⇄ 039	XYC blackout
		040 ⇄ 047	XYG blackout
		048 ⇄ 055	XYCG blackout
		056 ⇄ 095	no function
		096 ⇄ 103	X reset
		104 ⇄ 111	Y reset
		112 ⇄ 119	Color reset
		120 ⇄ 127	Gobo & gobo rotating reset
		128 ⇄ 135	No function
		136 ⇄ 143	Prism reset
		144 ⇄ 151	Framing shutter Reset
		152 ⇄ 159	All reset
		160 ⇄ 167	Iris reset
		168 ⇄ 175	Frost reset
		176 ⇄ 183	Zoom reset
		184 ⇄ 191	CMY reset
		192 ⇄ 199	Fan low speed
		200 ⇄ 207	Fan full speed
		208 ⇄ 215	Fan auto
		216 ⇄ 220	No function
		221 ⇄ 225	Iris Fast mode
226 ⇄ 230	Iris Smooth mode		
231 ⇄ 235	XY swap on		
236 ⇄ 240	XY swap off		
241 ⇄ 245	No function		
246 ⇄ 250	XY Fast mode		
251 ⇄ 255	XY Smooth mode		

## 33 Ch

Channel	Function	Value	Percent/Setting
1	Pan	000 ⇄ 255	0-100%
2	Fine Pan	000 ⇄ 255	Fine control (16-bit)
3	Tilt	000 ⇄ 255	0-100%
4	Fine Tilt	000 ⇄ 255	Fine control (16-bit)
5	Pan/Tilt Speed	000 ⇄ 255	0-100%
6	Dimmer	000 ⇄ 255	0-100%
7	Shutter	000 ⇄ 003	Closed
		004 ⇄ 007	Open
		008 ⇄ 076	Slow to fast
		077 ⇄ 145	Pulse effect from slow to fast
		146 ⇄ 215	Random effect from slow to fast
216 ⇄ 255	Open		
8	Virtual Strobe	000 ⇄ 001	No function
		002 ⇄ 128	Shaking strobe, slow to fast
		129 ⇄ 255	Fade in/out, slow to fast
9	Cyan	000 ⇄ 255	0-100%
10	Magenta	000 ⇄ 255	0-100%
11	Yellow	000 ⇄ 255	0-100%
12	CTO	000 ⇄ 255	0-100%

Channel	Function	Value	Percent/Setting
13	Color Wheel	000 ⇄ 006	Open
		007 ⇄ 013	Red
		014 ⇄ 020	Orange
		021 ⇄ 027	Green
		028 ⇄ 034	Blue
		035 ⇄ 041	Magenta
		042 ⇄ 048	CTO
		049 ⇄ 059	UV
		060 ⇄ 187	Split colors
		188 ⇄ 219	Clockwise color scroll, fast to slow
		220 ⇄ 223	Stop
224 ⇄ 255	Counter-clockwise color scroll, slow to fast		
14	Gobo Wheel 1	000 ⇄ 008	Open
		009 ⇄ 017	Gobo 1 (Circuits)
		018 ⇄ 026	Gobo 2 (Ring of Rings)
		027 ⇄ 035	Gobo 3 (Checker Vortex)
		036 ⇄ 044	Gobo 4 (Triangle)
		045 ⇄ 053	Gobo 5 (Star Field)
		054 ⇄ 063	Gobo 6 (Lenticular Glass)
		064 ⇄ 073	Gobo 6 Shaking
		074 ⇄ 082	Gobo 5 Shaking
		083 ⇄ 091	Gobo 4 Shaking
		092 ⇄ 100	Gobo 3 Shaking
		101 ⇄ 109	Gobo 2 Shaking
		110 ⇄ 118	Gobo 1 Shaking
		119 ⇄ 127	Open
		128 ⇄ 191	Clockwise gobo scroll, slow to fast
192 ⇄ 255	Counter-clockwise gobo scroll, slow to fast		
15	Gobo 1 Rotate	000 ⇄ 063	Rotating gobo index
		064 ⇄ 145	Clockwise rotating, fast to slow
		146 ⇄ 149	Stop
		150 ⇄ 231	Counter-clockwise rotating, slow to fast
		232 ⇄ 255	Bounce effect
16	Gobo Wheel 2	000 ⇄ 008	Open
		009 ⇄ 017	Gobo 1 (Spiral)
		018 ⇄ 026	Gobo 2 (Dot Chiclets)
		027 ⇄ 035	Gobo 3 (Splat Breakup)
		036 ⇄ 044	Gobo 4 (Wavy Bar)
		045 ⇄ 053	Gobo 5 (Shower Glass)
		054 ⇄ 063	Gobo 6 (Lenticular Glass)
		064 ⇄ 073	Gobo 6 Shaking
		074 ⇄ 082	Gobo 5 Shaking
		083 ⇄ 091	Gobo 4 Shaking
		092 ⇄ 100	Gobo 3 Shaking
		101 ⇄ 109	Gobo 2 Shaking
		110 ⇄ 118	Gobo 1 Shaking
		119 ⇄ 127	Open
		128 ⇄ 191	Clockwise gobo scroll, slow to fast
192 ⇄ 255	Counter-clockwise gobo scroll, slow to fast		
17	Gobo 2 Rotate	000 ⇄ 063	Rotating gobo index
		064 ⇄ 145	Clockwise rotating, fast to slow
		146 ⇄ 149	Stop
		150 ⇄ 231	Counter-clockwise rotating, slow to fast
		232 ⇄ 255	Bounce effect
18	Blade 1a	000 ⇄ 255	0-100%
19	Blade 1b	000 ⇄ 255	0-100%
20	Blade 2a	000 ⇄ 255	0-100%
21	Blade 2b	000 ⇄ 255	0-100%
22	Blade 3a	000 ⇄ 255	0-100%
23	Blade 3b	000 ⇄ 255	0-100%
24	Blade 4a	000 ⇄ 255	0-100%
25	Blade 4b	000 ⇄ 255	0-100%



Channel	Function	Value	Percent/Setting
26	Frame Rotate	000 ⇄ 255	0-100%
27	Focus	000 ⇄ 255	0-100%
28	Zoom	000 ⇄ 255	Narrow-wide
29	Prism	000 ⇄ 004	No function
		005 ⇄ 255	Prism Effect
30	Prism Rotate	000 ⇄ 127	Rotating position
		128 ⇄ 189	Clockwise rotating, fast to slow
		190 ⇄ 193	Stop
		194 ⇄ 255	Counter-clockwise rotating, slow to fast
31	Iris	000 ⇄ 063	Big to small
		064 ⇄ 127	Auto change, slow to fast
		128 ⇄ 191	Slow zoom out, fast zoom in (slow to fast)
		192 ⇄ 255	Slow zoom in, fast zoom out (slow to fast)
32	Frost	000 ⇄ 255	0-100%
33	Control	000 ⇄ 007	No function
		008 ⇄ 015	XY blackout
		016 ⇄ 023	C blackout
		024 ⇄ 031	G blackout
		032 ⇄ 039	XYC blackout
		040 ⇄ 047	XYG blackout
		048 ⇄ 055	XYCG blackout
		056 ⇄ 095	no function
		096 ⇄ 103	X reset
		104 ⇄ 111	Y reset
		112 ⇄ 119	Color reset
		120 ⇄ 127	Gobo & gobo rotating reset
		128 ⇄ 135	No function
		136 ⇄ 143	Prism reset
		144 ⇄ 151	Framing shutter Reset
		152 ⇄ 159	All reset
		160 ⇄ 167	Iris reset
		168 ⇄ 175	Frost reset
		176 ⇄ 183	Zoom reset
		184 ⇄ 191	CMY reset
		192 ⇄ 199	Fan low speed
		200 ⇄ 207	Fan full speed
		208 ⇄ 215	Fan auto
		216 ⇄ 220	No function
		221 ⇄ 225	Iris Fast mode
		226 ⇄ 230	Iris Smooth mode
		231 ⇄ 235	XY swap on
		236 ⇄ 240	XY swap off
241 ⇄ 245	No function		
246 ⇄ 250	XY Fast mode		
251 ⇄ 255	XY Smooth mode		

**Design Wheels**

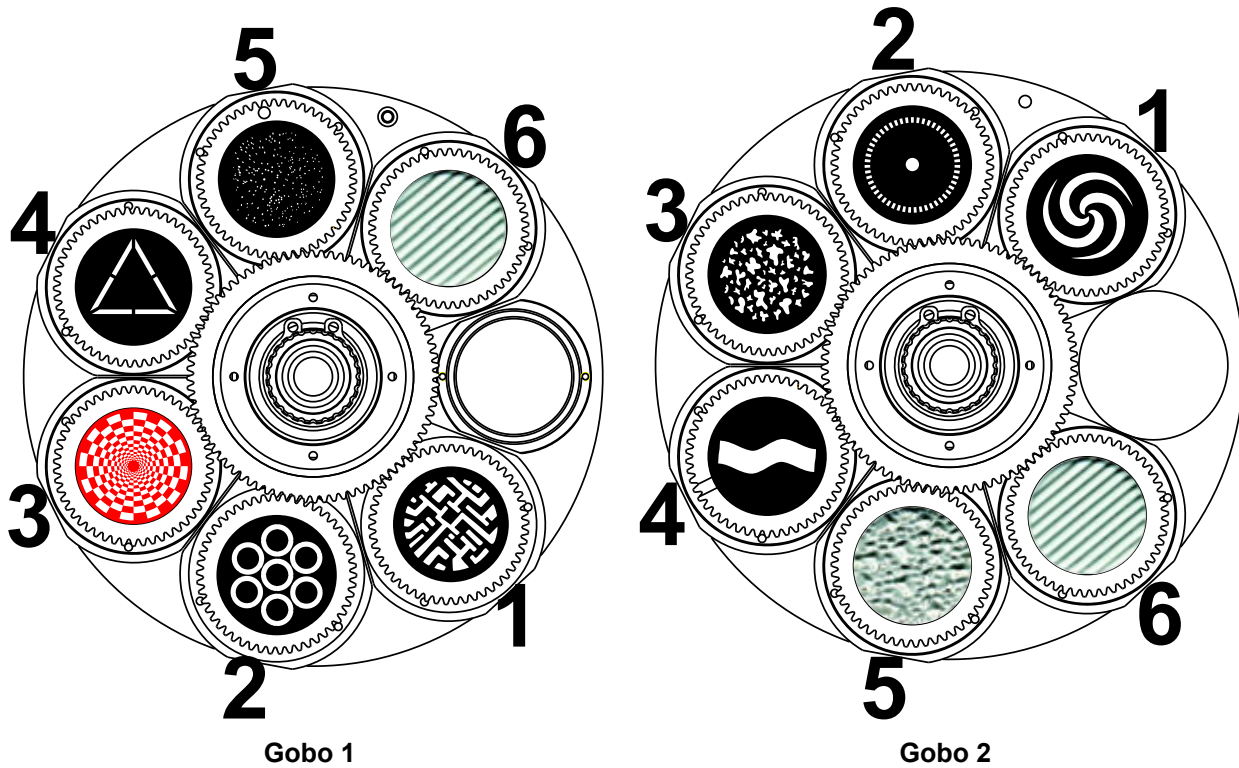

**Gobo Wheels**

Gobo Wheel	Gobo #	Description
1	1	Circuits
	2	Ring of Rings
	3	Checker Vortex
	4	Triangle
	5	Star Field
	6	Lenticular Glass
2	1	Spiral
	2	Dot Chiclets
	3	Splat Breakup
	4	Wavy Bar
	5	Shower Glass
	6	Lenticular Glass

## Gobo Replacement

The gobos in gobo wheel 1 are removable from their gobo holders. This operation is quite simple, although it requires the technician to carefully follow the recommended procedure.

- **Make sure to disconnect the product's power cord before replacing a gobo.**
- **Always replace a gobo with a gobo of the same dimensions.**
- **When inserting a glass gobo, always make sure that the shiny side of the gobo (glass base) faces the lamp. This provides a layer of protection against the high temperature from the lamp.**

### Procedure

1. Turn the product off and disconnect it from the power outlet.
2. Open the head cover by loosening the 4 Phillips-head ¼-turn screws on the sides of the top cover.
3. Separate the gobo holder away from the gobo wheel by pushing it toward the front of the moving head (direction 1 in the diagram). Be careful not to push the gobo out of the gobo holder.
4. Extract the gobo holder by pulling it outward (direction 2 in the diagram).
5. On a flat surface, remove the expansion ring that holds the gobo in place and remove the gobo from the gobo holder.
6. Insert a new gobo and hold it in place with the expansion ring.
7. Slide the tip of the gobo holder under the pressure plate near the center of the gobo wheel.
8. Push the gobo holder inwards. **DO NOT** force the gobo holder into the gobo wheel slot. If correctly installed, the gobo holder should easily slide into the gobo wheel slot.

### Diagram

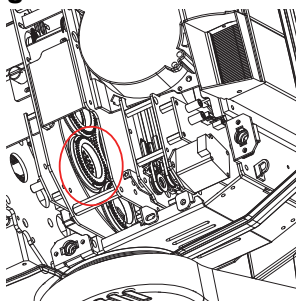

Locate

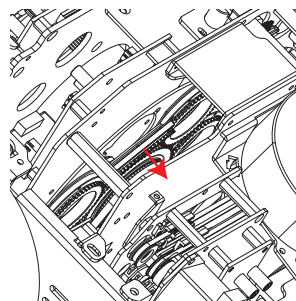

Pull Back

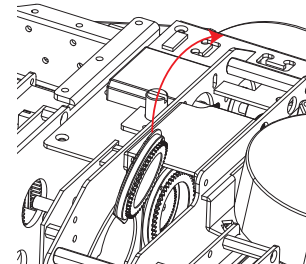

Remove

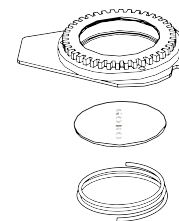
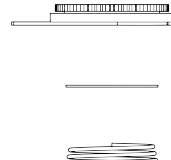
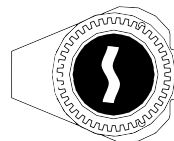
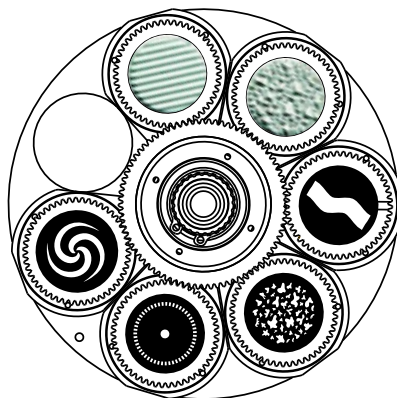

Gobo Holder

Gobo

Retaining Spring

**Color Wheel**

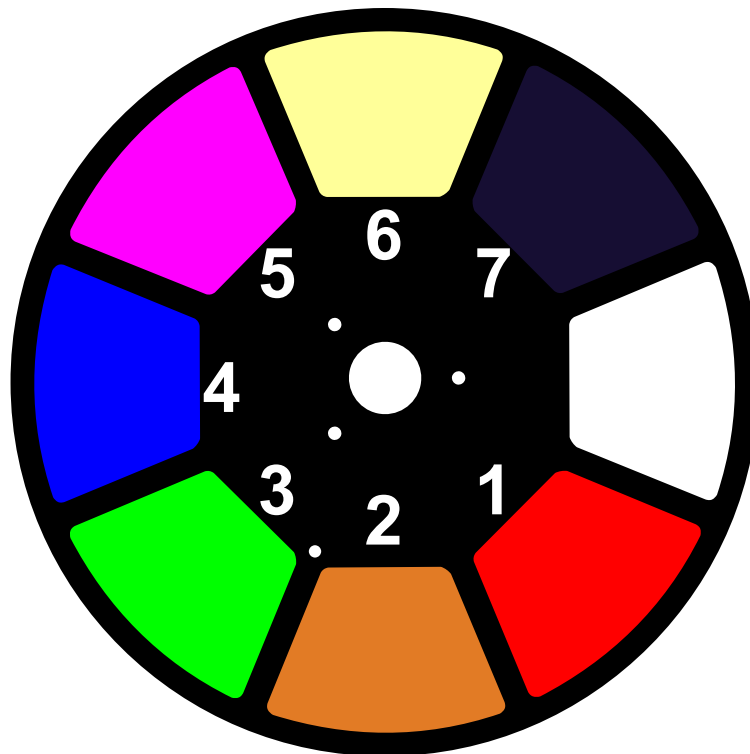

**Color Wheel**

Color #	Description
1	Red
2	Orange
3	Green
4	Blue
5	Magenta
6	CTO
7	UV

**Offset Mode**

The Offset mode provides fine adjustments for the home position of all the moving parts in the optical path as well as the pan and tilt movements. This way, when in their home position, the moving parts do not show any border or reduce the light output.

1. Starting from the Main Level screen, press and hold **<MENU>** until the passcode screen appears.
  2. Enter the passcode **2323** using one of the following methods:
    - Through the touchscreen: use the number pad on the screen to enter **2323**.
    - With the buttons:
      - a. Use **<DOWN>** to select the number to be changed.
      - b. Use **<UP>** to increase the value.
      - c. Repeat until **2323** has been entered.
  3. Press **<ENTER>**.
- This brings you into the Zero Adjust menu screen.

## OPERATION

---

### PAN

1. Use <UP> or <DOWN> to select **PAN**.
2. Press <ENTER>.
3. Use <UP> or <DOWN> to increase or decrease the starting value, from **000–255**.
4. Press <ENTER>.

### TILT

1. Use <UP> or <DOWN> to select **TILT**.
2. Press <ENTER>.
3. Use <UP> or <DOWN> to increase or decrease the starting value, from **000–255**.
4. Press <ENTER>.

### COLOR

1. Use <UP> or <DOWN> to select **COLOR**.
2. Press <ENTER>.
3. Use <UP> or <DOWN> to increase or decrease the starting value, from **000–255**.
4. Press <ENTER>.

### GOBO

1. Use <UP> or <DOWN> to select **GOBO**.
2. Press <ENTER>.
3. Use <UP> or <DOWN> to increase or decrease the starting value, from **000–255**.
4. Press <ENTER>.

### GOBO ROTATE

1. Use <UP> or <DOWN> to select **GOBO ROTATE**.
2. Press <ENTER>.
3. Use <UP> or <DOWN> to increase or decrease the starting value, from **000–255**.
4. Press <ENTER>.

### GOBO 2

1. Use <UP> or <DOWN> to select **GOBO 2**.
2. Press <ENTER>.
3. Use <UP> or <DOWN> to increase or decrease the starting value, from **000–255**.
4. Press <ENTER>.

### GOBO 2 ROTATE

1. Use <UP> or <DOWN> to select **GOBO 2 ROTATE**.
2. Press <ENTER>.
3. Use <UP> or <DOWN> to increase or decrease the starting value, from **000–255**.
4. Press <ENTER>.

### FOCUS1-GOBO 2

1. Use <UP> or <DOWN> to select **FOCUS1-GOBO 2**.
2. Press <ENTER>.
3. Use <UP> or <DOWN> to increase or decrease the starting value, from **000–255**.
4. Press <ENTER>.

### FOCUS2

1. Use <UP> or <DOWN> to select **FOCUS2**.
2. Press <ENTER>.
3. Use <UP> or <DOWN> to increase or decrease the starting value, from **000–255**.
4. Press <ENTER>.

### FOCUS-GOBO

1. Use <UP> or <DOWN> to select **FOCUS GOBO**.
2. Press <ENTER>.
3. Use <UP> or <DOWN> to increase or decrease the starting value, from **000–255**.
4. Press <ENTER>.

**ZOOM**

1. Use <UP> or <DOWN> to select **ZOOM**.
2. Press <ENTER>.
3. Use <UP> or <DOWN> to increase or decrease the starting value, from **000–255**.
4. Press <ENTER>.

**PRISM**

1. Use <UP> or <DOWN> to select **PRISM**.
2. Press <ENTER>.
3. Use <UP> or <DOWN> to increase or decrease the starting value, from **000–255**.
4. Press <ENTER>.

**IRIS**

1. Use <UP> or <DOWN> to select **IRIS**.
2. Press <ENTER>.
3. Use <UP> or <DOWN> to increase or decrease the starting value, from **000–255**.
4. Press <ENTER>.

**FROST**

1. Use <UP> or <DOWN> to select **FROST**.
2. Press <ENTER>.
3. Use <UP> or <DOWN> to increase or decrease the starting value, from **000–255**.
4. Press <ENTER>.

**CYAN**

1. Use <UP> or <DOWN> to select **CYAN**.
2. Press <ENTER>.
3. Use <UP> or <DOWN> to increase or decrease the starting value, from **000–255**.
4. Press <ENTER>.

**MAGENTA**

1. Use <UP> or <DOWN> to select **MAGENTA**.
2. Press <ENTER>.
3. Use <UP> or <DOWN> to increase or decrease the starting value, from **000–255**.
4. Press <ENTER>.

**YELLOW**

1. Use <UP> or <DOWN> to select **YELLOW**.
2. Press <ENTER>.
3. Use <UP> or <DOWN> to increase or decrease the starting value, from **000–255**.
4. Press <ENTER>.

**CTO**

1. Use <UP> or <DOWN> to select **CTO**.
2. Press <ENTER>.
3. Use <UP> or <DOWN> to increase or decrease the starting value, from **000–255**.
4. Press <ENTER>.

**BLADE 1-1**

1. Use <UP> or <DOWN> to select **BLADE 1-1**.
2. Press <ENTER>.
3. Use <UP> or <DOWN> to increase or decrease the starting value, from **000–255**.
4. Press <ENTER>.

**BLADE 1-2**

1. Use <UP> or <DOWN> to select **BLADE 1-2**.
2. Press <ENTER>.
3. Use <UP> or <DOWN> to increase or decrease the starting value, from **000–255**.
4. Press <ENTER>.

**BLADE 2-1**

1. Use <UP> or <DOWN> to select **BLADE 2-1**.
2. Press <ENTER>.
3. Use <UP> or <DOWN> to increase or decrease the starting value, from **000–255**.
4. Press <ENTER>.

**BLADE 2-2**

1. Use <UP> or <DOWN> to select **BLADE 2-2**.
2. Press <ENTER>.
3. Use <UP> or <DOWN> to increase or decrease the starting value, from **000–255**.
4. Press <ENTER>.

**BLADE 3-1**

1. Use <UP> or <DOWN> to select **BLADE 3-1**.
2. Press <ENTER>.
3. Use <UP> or <DOWN> to increase or decrease the starting value, from **000–255**.
4. Press <ENTER>.

**BLADE 3-2**

1. Use <UP> or <DOWN> to select **BLADE 3-2**.
2. Press <ENTER>.
3. Use <UP> or <DOWN> to increase or decrease the starting value, from **000–255**.
4. Press <ENTER>.

**BLADE 4-1**

1. Use <UP> or <DOWN> to select **BLADE 4-1**.
2. Press <ENTER>.
3. Use <UP> or <DOWN> to increase or decrease the starting value, from **000–255**.
4. Press <ENTER>.

**BLADE 4-2**

1. Use <UP> or <DOWN> to select **BLADE 4-2**.
2. Press <ENTER>.
3. Use <UP> or <DOWN> to increase or decrease the starting value, from **000–255**.
4. Press <ENTER>.

**BLADE ROTATE**

1. Use <UP> or <DOWN> to select **BLADE ROTATE**.
2. Press <ENTER>.
3. Use <UP> or <DOWN> to increase or decrease the starting value, from **000–255**.
4. Press <ENTER>.

**DIMMER 1**

1. Use <UP> or <DOWN> to select **BLADE 1-1**.
2. Press <ENTER>.
3. Use <UP> or <DOWN> to increase or decrease the starting value, from **000–255**.
4. Press <ENTER>.

**DIMMER 2**

1. Use <UP> or <DOWN> to select **BLADE 1-1**.
2. Press <ENTER>.
3. Use <UP> or <DOWN> to increase or decrease the starting value, from **000–255**.
4. Press <ENTER>.

**MAC4**

1. Use <UP> or <DOWN> to select **MAC4**.
2. Press <ENTER>.
3. Use <UP> or <DOWN> to increase or decrease the starting value, from **000–255**.
4. Press <ENTER>.

### MAC5

1. Use <UP> or <DOWN> to select **MAC5**.
2. Press <ENTER>.
3. Use <UP> or <DOWN> to increase or decrease the starting value, from **000–255**.
4. Press <ENTER>.

### MAC6

1. Use <UP> or <DOWN> to select **MAC6**.
2. Press <ENTER>.
3. Use <UP> or <DOWN> to increase or decrease the starting value, from **000–255**.
4. Press <ENTER>.

## Web Server

The Maverick MK2 Profile Web Server can be accessed by any computer on the same network as the product. It allows network access to system information, settings such as control setup, manual testing of all functions, firmware updates, and the ability to change the Web Server password.

1. Connect the product to power, and set the Control [Protocol](#) to **Art-Net** and the [IP Mode](#) to **Static**.
2. Connect the product to a Windows computer with a network cable.
3. On the computer, set the IP address of the new network to the same first 3 digits as the IP address of the product (See [Artnet IP Address](#)).
4. Enter the IP address of the product into the URL bar of a web browser on the computer.
5. Enter both the User Name and Password as **admin** to log in.

### Information

The Information page on the Web Server displays the current settings and the system information of the Maverick MK2 Profile.

### Setup

The Setup page on the Web Server provides options for control, similar to the **Setup** menu on the product. Click **Save Settings** to send the new configuration to the product.

### Manual Test

The Manual Test page on the Web Server allows all output functions of the product to be controlled through the browser. To set all functions back to default, click **Reset**.

### Security

The Security page on the Web Server gives the option to change the password to the connected product's web server. Enter the old password (**admin**, by default) and the new password twice, then click **Save Settings** to change the password.



## 5. TECHNICAL INFORMATION

### Product Maintenance

To maintain optimum performance and minimize wear, clean this product frequently. Usage and environment are contributing factors in determining the cleaning frequency.

Clean this product at least twice a month. Dust build-up reduces light output performance and can cause overheating. This can lead to reduced light source life and increased mechanical wear.

To clean the product:

1. Unplug the product from power.
2. Wait until the product is at room temperature.
3. Use a vacuum (or dry compressed air) and a soft brush to remove dust collected on the external vents.
4. Clean all transparent surfaces with a mild soap solution, ammonia-free glass cleaner, or isopropyl alcohol.
5. Apply the solution directly to a soft, lint free cotton cloth or a lens cleaning tissue.
6. Softly drag any dirt or grime to the outside of the transparent surface.
7. Gently polish the transparent surfaces until they are free of haze and lint.



**Always dry the transparent surfaces carefully after cleaning them.**

## 6. TECHNICAL SPECIFICATIONS

### Dimensions and Weight

Length	Width	Height	Weight
15.5 in (394 mm)	10.9 in (279 mm)	26.7 in (679 mm)	69.8 lb (31.7 kg)

**Note:** Dimensions in inches rounded to the nearest hundredth.

### Power

Power Supply Type	Range	Voltage Selection
Switching (internal)	100 to 240 VAC, 50/60 Hz	Auto-ranging

Parameter	120 V, 60 Hz	230 V, 50 Hz
Consumption	750 W	734 W
Operating Current	6.32 A	3.1 A
Power linking current (products)	13.6 A (X products)	13.6 A (X products)
Fuse	F 12 A, 250 V	F 12 A, 250 V

Power I/O	U.S./Canada	Worldwide
Power input connector	Seetronic Powerkon IP65	Seetronic Powerkon IP65
Power output connector	Seetronic Powerkon IP65	Seetronic Powerkon IP65
Power Cord plug	Edison (U.S.)	Local Plug

### Light Source

Type	Power	Lifespan
LED	469.1 W	50,000 hours

Color	Quantity	Current
Cool White	1	6.5 A

### Photometrics

Parameter	Narrow Zoom	Wide Zoom
Beam Angle	12°	35°
Field Angle	13°	37°
Illuminance @ 5 m	14,981 lux	2,098 lux

### Thermal

Maximum External Temperature	Cooling System
113 °F (45 °C)	Convection

### DMX

I/O Connector	Channel Range
3- and 5-pin XLR	33 or 50

### Ordering

Product Name	Item Code	UPC Number
Maverick MK2 Profile	08011312	781462216603



UL 1573  
CSA C22.2 No. 166  
E113093



RoHS



### Photometrics Chart

Distance	Narrow		Zoomable Light Source		Wide	
	Beam Diameter	Field Diameter	Footcandle	Footcandle	Beam Diameter	Field Diameter
15 ft	3.15 ft	3.42 ft	1,665	233	9.46 ft	10.04 ft
20 ft	4.20 ft	4.56 ft	936	131	12.61 ft	13.38 ft
30 ft	6.31 ft	6.84 ft	416	58	18.92 ft	20.08 ft
40 ft	8.41 ft	9.11 ft	234	33	25.22 ft	26.77 ft
50 ft	10.51 ft	11.39 ft	150	21	31.53 ft	33.46 ft
75 ft	15.77 ft	17.09 ft	67	9	47.29 ft	50.19 ft
100 ft	21.02 ft	22.79 ft	37	5	63.06 ft	66.92 ft
125 ft	26.28 ft	28.48 ft	24	3	78.82 ft	83.65 ft
150 ft	31.53 ft	34.18 ft	17	2	94.59 ft	100.38 ft

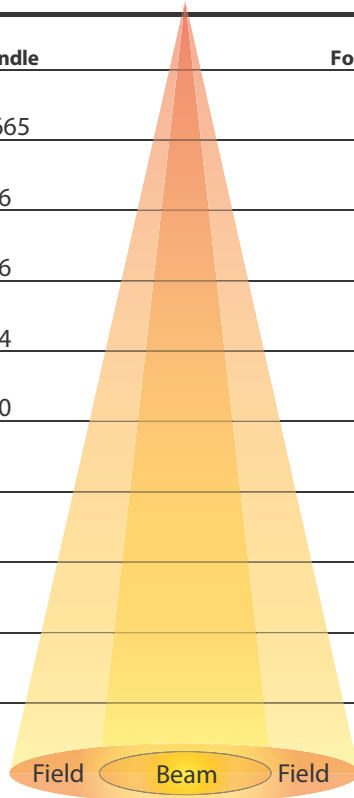

Distance	Narrow		Zoomable Light Source		Wide	
	Beam Diameter	Field Diameter	Lux	Lux	Beam Diameter	Field Diameter
1 m	0.21 m	0.23 m	374,525	52,450	0.63 m	0.67 m
2 m	0.42 m	0.46 m	93,631	13,113	1.26 m	1.34 m
5 m	1.05 m	1.14 m	14,981	2,098	3.15 m	3.35 m
8 m	1.68 m	1.82 m	5,852	820	5.04 m	5.35 m
10 m	2.10 m	2.28 m	3,745	525	6.31 m	6.69 m
15 m	3.15 m	3.42 m	1,665	233	9.46 m	10.04 m
20 m	4.20 m	4.56 m	936	131	12.61 m	13.38 m
25 m	5.26 m	5.70 m	599	84	15.76 m	16.73 m
30 m	6.31 m	6.84 m	416	58	18.92 m	20.08 m

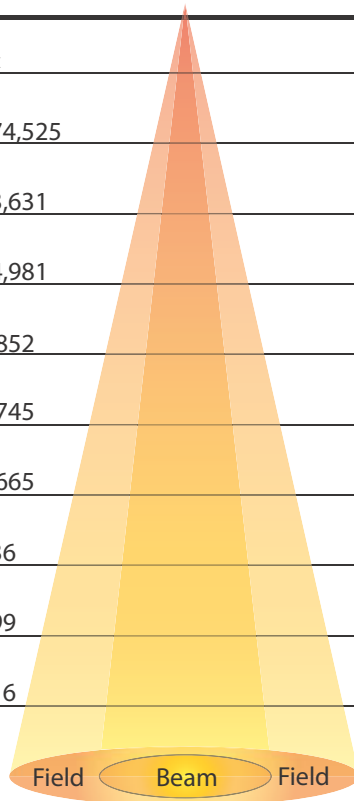

## RETURNS

Send the product prepaid, in the original box, and with the original packing and accessories. Chauvet will not issue call tags.

Call Chauvet and request a Return Merchandise Authorization (RMA) number before shipping the product. Be prepared to provide the model number, serial number, and a brief description of the cause(s) for the return.

Clearly label the package with an RMA number. Chauvet will refuse any product returned without an RMA number.



**Write the RMA number on a properly affixed label. DO NOT write the RMA number directly on the box.**

Once you have the RMA number, provide the following information on a piece of paper and place it inside the box:

- Your name
- Your address
- Your phone number
- RMA number
- A brief description of the problem

Be sure to pack the product properly. Any shipping damage resulting from inadequate packaging will be your responsibility. FedEx packing or double-boxing are recommended.



**Chauvet reserves the right to use its own discretion to repair or replace returned product(s).**

## CONTACT US

World Headquarters	
General Information	Technical Support
Address: 5200 NW 108th Ave. Sunrise, FL 33351 Voice: (954) 577-4455 Fax: (954) 929-5560 Toll Free: (800) 762-1084	Voice: (844) 393-7575 Fax: (954) 756-8015 Email: <a href="mailto:chauvetcs@chauvetlighting.com">chauvetcs@chauvetlighting.com</a>
	<b>Website</b> <a href="http://www.chauvetlighting.com">www.chauvetlighting.com</a>
EUROPE	
General Information	Technical Support
Address: Stokstraat 18 9770 Kruishoutem Belgium Voice: +32 9 388 93 97	Email: <a href="mailto:eutech@chauvetlighting.eu">eutech@chauvetlighting.eu</a>
	<b>Website</b> <a href="http://www.chauvetlighting.eu">www.chauvetlighting.eu</a>
General Information	
General Information	Technical Support
Address: Unit 1C Brookhill Road Industrial Estate Pinxton, Nottingham, UK NG16 6NT Voice: +44 (0) 1773 511115 Fax: +44 (0) 1773 511110	Email: <a href="mailto:uktech@chauvetlighting.com">uktech@chauvetlighting.com</a>
	<b>Website</b> <a href="http://www.chauvetlighting.co.uk">www.chauvetlighting.co.uk</a>
MEXICO	
General Information	Technical Support
Address: Av. de las Partidas 34, 3-B (Entrance by Calle 2) Zona Industrial Lerma Lerma, Edo. de México, CP 52000 Voice: +52 (728) 690-2010	Email: <a href="mailto:servicio@chauvet.com.mx">servicio@chauvet.com.mx</a>
	<b>Website</b> <a href="http://www.chauvet.com.mx">www.chauvet.com.mx</a>

Visit the applicable website above to verify our contact information and instructions to request support. Outside the U.S., United Kingdom, Ireland, Mexico or Benelux, contact the dealer of record.