

MAVERICK

MK2 SPOT

User Manual

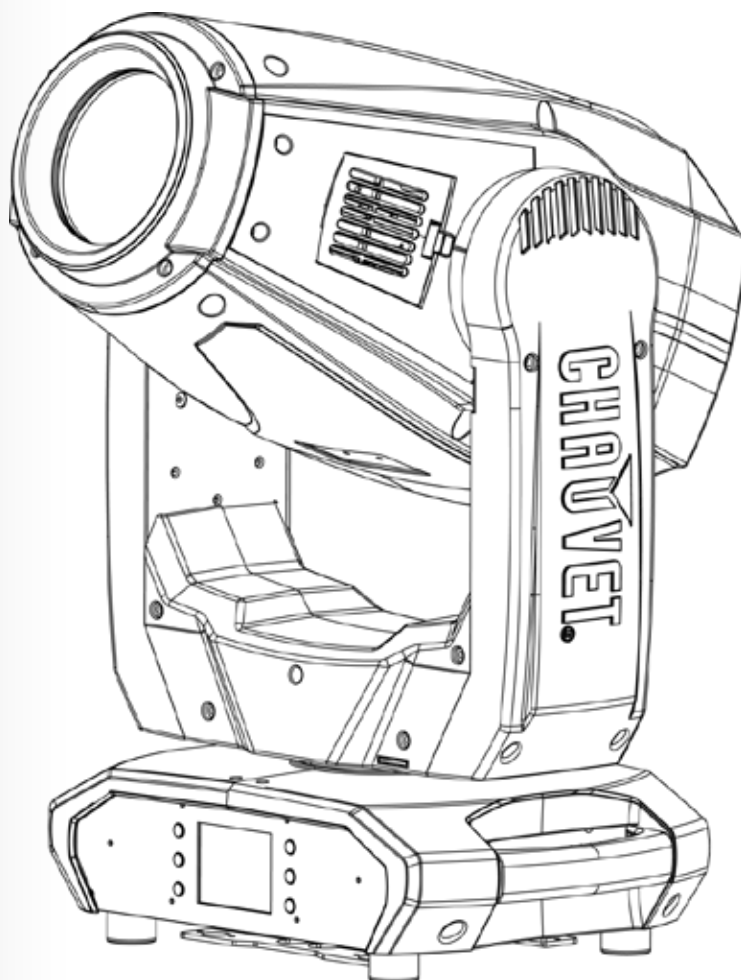

CHAUVET[®]
PROFESSIONAL

Edition Notes	The Maverick MK2 Spot User Manual Rev. 3 covers the description, safety precautions, installation, programming, operation, and maintenance of the Maverick MK2 Spot. Chauvet released this edition of the Maverick MK2 Spot User Manual in <u>September 2016</u> .
Trademarks	CHAUVET, the Chauvet logo and Maverick MK2 Spot are registered trademarks or trademarks of Chauvet & Sons, LLC. (d/b/a Chauvet and Chauvet Lighting) in the United States and other countries. Other company and product names and logos referred to herein may be trademarks of their respective companies.
Copyright Notice	The works of authorship contained in this manual, including, but not limited to, all design, text and images are owned by Chauvet. © Copyright 2016 Chauvet & Sons, LLC. All rights reserved. Electronically published by Chauvet in the United States of America.
Manual Use	Chauvet authorizes its customers to download and print this manual for professional information purposes only. Chauvet expressly prohibits the usage, copy, storage, distribution, modification, or printing of this manual or its content for any other purpose without written consent from Chauvet.
Document Printing	For better results, print this document in color, on letter size paper (8.5 x 11 in), double-sided. If using A4 paper (210 x 297 mm), configure your printer to scale the content accordingly.
Intended Audience	Any person in charge of installing, operating, and/or maintaining this product should completely read through the guide that shipped with the product, as well as this manual, before installing, operating, or maintaining this product.
Disclaimer	Chauvet believes that the information contained in this manual is accurate in all respects. However, Chauvet assumes no responsibility and specifically disclaims any and all liability to any party for any loss, damage or disruption caused by any errors or omissions in this document, whether such errors or omissions result from negligence, accident or any other cause. Chauvet reserves the right to revise the content of this document without any obligation to notify any person or company of such revision, however, Chauvet has no obligation to make, and does not commit to make, any such revisions.
Document Revision	The Maverick MK2 Spot User Manual Rev. 4 supersedes all previous versions of this manual. Discard any older versions of this manual and replace with this version. Go to www.chauvetprofessional.com for the latest version.

Table of Contents



1. Before You Begin	1
What Is Included	1
Claims.....	1
Manual Conventions	1
Symbols.....	1
Product At A Glance	1
Safety Notes	2
Personal Safety.....	2
Mounting And Rigging.....	2
Power And Wiring	2
Operation	2
Expected LED Lifespan	2
2. Introduction	3
Description	3
Features at a glance	3
Overview	3
Dimensions	4
3. Setup	5
AC Power.....	5
AC Plug.....	5
Fuse Replacement.....	5
Mounting	6
Orientation	6
Signal Connections.....	7
Art-Net™ Connection.....	7
sACN Connection	7
4. Operation	8
Touchscreen and Control Panel Description	8
Menu Map	8
Operating Settings Configuration.....	12
Home Screen.....	12
Network Setup	12
Personality	14
Settings.....	14
Test Mode.....	18
System Information	18
Offset Mode	19
DMX Values	21
32CH.....	21
24CH.....	23
Gobo Designs	26
Color Wheel	26
Gobo Replacement	27
5. Firmware Update	28
6. Technical Information	31
Product Maintenance	31
Error Indication.....	31
7. Technical Specifications	32
Returns	33
Contact Us	34

1. BEFORE YOU BEGIN

- What Is Included**
- Maverick MK2 Spot
 - True 1 compatible power cord
 - 2 Omega brackets
 - Warranty card
 - User Manual

Claims Carefully unpack the product immediately and check the box to make sure all the parts are in the package and are in good condition. If the box or the contents (the product and included accessories) appear damaged from shipping or show signs of mishandling, notify the carrier immediately, not Chauvet. Failure to report damage to the carrier immediately may invalidate your claim. In addition, keep the box and contents for inspection. For other issues, such as missing components or parts, damage not related to shipping, or concealed damage, file a claim with Chauvet within 7 days of delivery.

Manual Conventions	Convention	Meaning
	1–512	A range of values in the text
	50/60	A set of mutually exclusive values in the text
	<SET>	A button on the product’s control panel
	Settings	A product function or a menu option
	MENU>Settings	A sequence of menu options
	ON	A unique value to be entered or selected in a menu

Symbols	Symbols	Meaning
		Critical installation, configuration, or operation information. Failure to comply with this information may cause the product not to work, damage third-party equipment, or cause harm to the operator.
		Important installation or configuration information. Failure to comply with this information may keep the product from working.
		Useful information.

 The term “DMX” used throughout this manual refers to the USITT DMX512-A digital data transmission protocol.

Product At A Glance	Use on Dimmer	X	Auto Programs	X
	Outdoor Use	X	Auto-Ranging Power Supply	P
	Master/Slave	X	Replaceable Fuse	P
	DMX	P	User-Serviceable	X

Safety Notes

Read all the following Safety Notes before working with this product. These notes include important information about the installation, usage, and maintenance of this product.



This product contains no user-serviceable parts. Any reference to servicing in this User Manual will only apply to properly trained Chauvet certified technicians. Do not open the housing or attempt any repairs.



All applicable local codes and regulations apply to proper installation of this product.

Personal Safety

- Avoid direct eye exposure to the light source while the product is on.
- Always disconnect this product from its power source before servicing.
- Always connect this product to a grounded circuit to avoid the risk of electrocution.
- Do not touch this product's housing during operation because it may be very hot.

Mounting And Rigging

- This product is for indoor use only! To prevent risk of fire or shock, do not expose this product to rain or moisture. (IP20)
- CAUTION: When transferring product from extreme temperature environments, (e.g. cold truck to warm humid ballroom) condensation may form on the internal electronics of the product. To avoid causing a failure, allow product to fully acclimate to the surrounding environment before connecting it to power.
- Mount this product in a location with adequate ventilation, at least 20 in (50 cm) from adjacent surfaces.
- Make sure there are no flammable materials close to this product while it is operating.
- When hanging this product, always secure to a fastening device using a safety cable.
- Never carry the product by the power cord or any moving part.

Power And Wiring

- Make sure the power cord is not crimped or damaged.
- Always make sure you are connecting this product to the proper voltage in accordance with the specifications in this manual or on the product's specification label.
- To eliminate unnecessary wear and improve its lifespan, during periods of non-use completely disconnect the product from power via breaker or by unplugging it.
- Never connect this product to a dimmer pack or rheostat.
- Make sure to replace the fuse with another of the same type and rating.
- Never disconnect this product by pulling or tugging on the power cable.

Operation

- Do not operate this product if you see damage on the housing, lenses, or cables. Have the damaged parts replaced by an authorized technician at once.
- Do not cover the ventilation slots when operating to avoid internal overheating.
- The maximum ambient temperature is 113 °F (45 °C). Do not operate this product at a higher temperature.
- In case of a serious operating problem, stop using this product immediately!



If your Chauvet product requires service, contact Chauvet Technical Support.

Expected LED Lifespan

LEDs gradually decline in brightness over time, mostly because of heat. Packaged in clusters, LEDs exhibit higher operating temperatures than in ideal, single-LED conditions. For this reason, using clustered LEDs at their fullest intensity significantly reduces the LEDs' lifespan. Under normal conditions, this lifespan can be 40,000 to 50,000 hours. If extending this lifespan is vital, lower the operating temperature by improving the ventilation around the product and reducing the ambient temperature to an optimal operating range. In addition, limiting the overall projection intensity may also help to extend the LEDs' lifespan.

2. INTRODUCTION

Description Stunningly bright with precision engineered optics and a color mixing system that will leave you breathless, the Maverick MK2 Spot sets new standards in moving head LED spots. Powered by an industry leading 440W LED engine, this fixture boasts a CMY+CTO color mixing system, two 6 position rotating slot and lock gobo wheels, a 7 position + white color wheel, variable frost and 3 facet prism. All of this projected through a 13° to 37° zoom system. With the ability to control the Maverick MK2 Spot over DMX, Art-Net, or by WDMX, there is an option for every situation. As an added feature, this fixture can receive Art-Net in, and send out DMX, simplifying cable runs.

- Features at a glance**
- 440W LED light engine
 - 16-bit Dimming
 - Variable CMY+CTO color mixing
 - Two rotating, indexing and interchangeable slot and lock gobos
 - DMX , WDMX, sACN, and Art-Net control
 - 13° to 37° Zoom angle
 - Iris, 3-facet prism, and frost for beam control
 - True 1 compatible power input

Overview

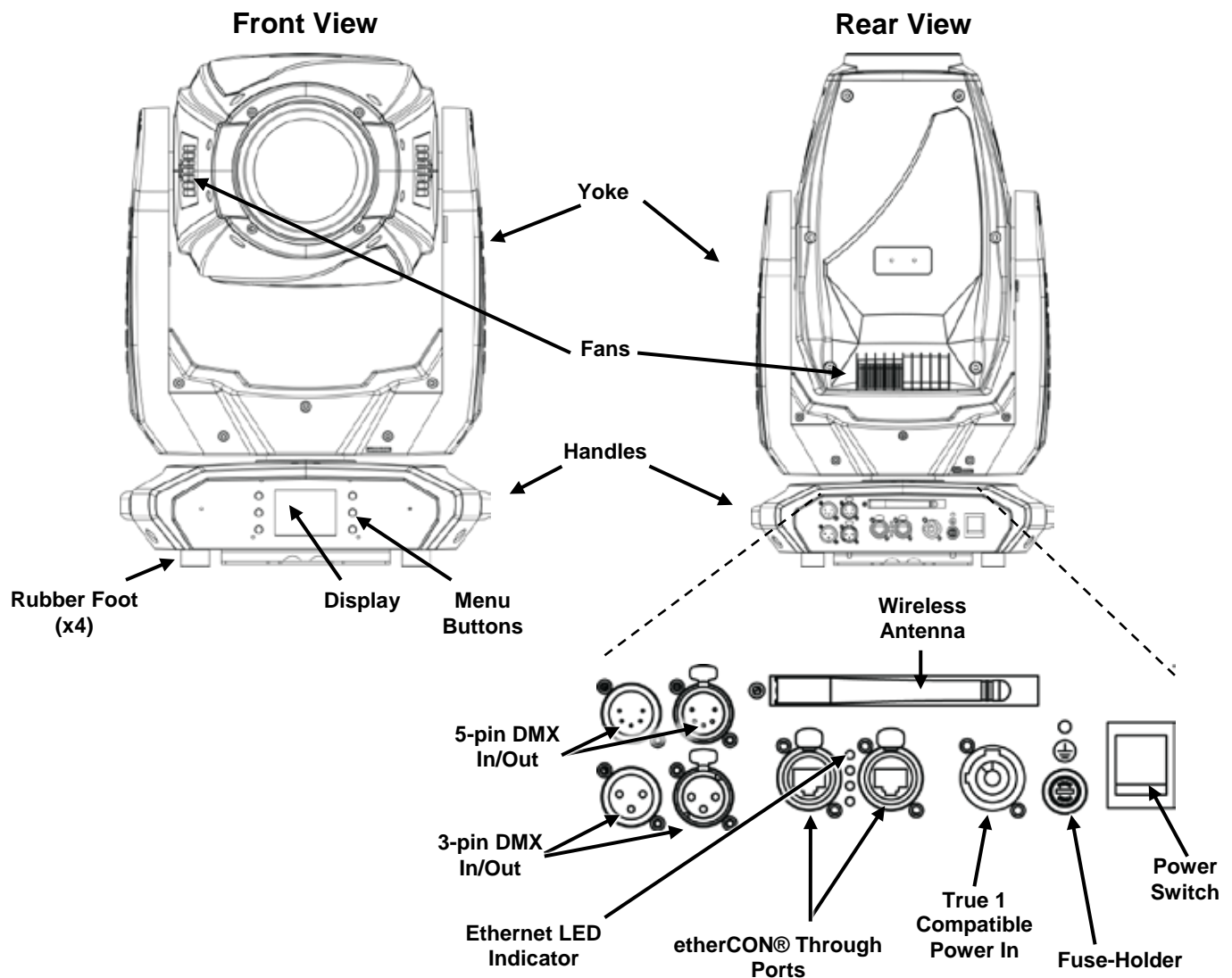

Dimensions

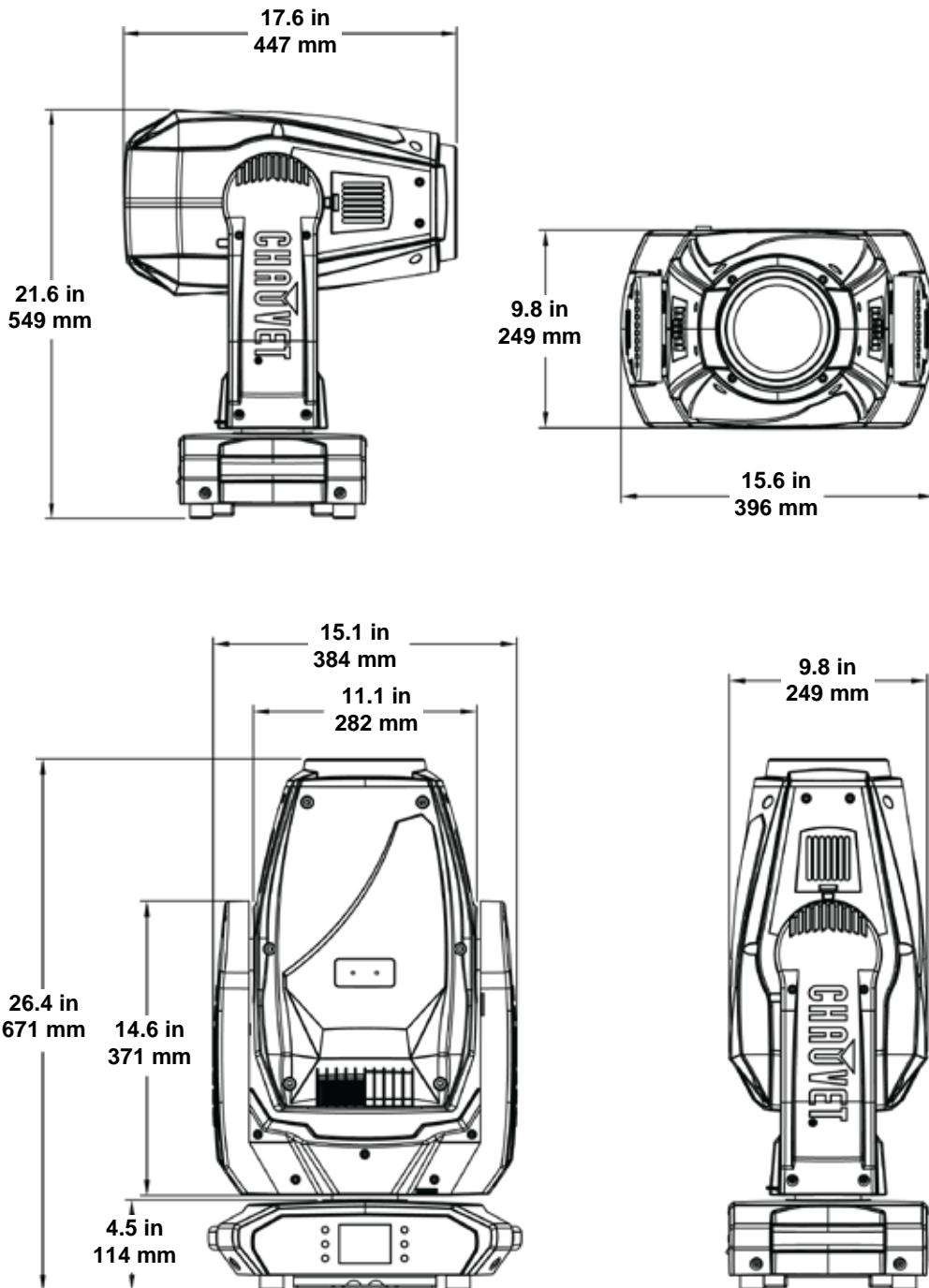

3. SETUP

AC Power

Each Maverick MK2 Spot has an auto-ranging power supply that works with an input voltage range of 100 to 240 VAC, 50/60 Hz. To determine the power requirements for each Maverick MK2 Spot, refer to the label affixed to the product. You can also refer to the [Technical Specifications](#) chart in this manual.

The listed current rating indicates the maximum current draw during normal operation. For more information, you may download Sizing Circuit Breakers from the Chauvet website: www.chauvetprofessional.com.



- **Always connect this product to a protected circuit with an appropriate electrical ground to avoid the risk of electrocution or fire.**
- **Never connect this product to a rheostat (variable resistor) or dimmer circuit, even if the rheostat or dimmer channel serves only as a 0 to 100% switch.**
- **To eliminate unnecessary wear and improve its lifespan, during periods of non-use completely disconnect the product from power via breaker or by unplugging it.**

AC Plug

The Maverick MK2 Spot comes with a power input cord terminated with a True 1 compatible connector on one end and an Edison plug on the other end (U.S. market). If the power input cord that came with your product has no plug, or if you need to change the Edison plug, use the table below to wire the new plug.

Connection	Wire (U.S.)	Wire (Europe)	Screw Color
AC Live	Black	Brown	Yellow or Brass
AC Neutral	White	Blue	Silver
AC Ground	Green/Yellow	Green/Yellow	Green

Fuse Replacement

1. Disconnect this product from the power outlet.
2. Using a flat-head screwdriver, unscrew the fuse holder cap from the housing.
3. Remove the blown fuse and replace with another fuse of the same type and rating (F 10 A, 250 V).
4. Screw the fuse holder cap back in place and reconnect power.



Make sure to disconnect the product's power cord before replacing a blown fuse. Always replace the blown fuse with another of the same type and rating.

Mounting Before mounting this product, read and follow the [Safety Notes](#). For our CHAUVET Professional line of mounting clamps, go to <http://trusst.com/products/>.

Orientation Always mount this product in a safe position and make sure there is adequate room for ventilation, configuration, and maintenance. The Maverick MK2 Spot can be suspended upright or upside down using the 2 Omega brackets included, or it can be placed on its rubber feet on a flat level surface.

Chauvet recommends using the following general guidelines when mounting this product:

- When selecting an installation location, consider easy access to this product for operation, programming adjustments, and routine maintenance.
- Make sure to mount this product away from any flammable material as indicated in the [Safety Notes](#).
- Never mount in places where rain, high humidity, extreme temperature changes, or restricted ventilation may affect the product.
- If hanging this product, make sure that the mounting location can support the product's weight. See the [Technical Specifications](#) for the weight-bearing requirements of this product.
- When hanging this product, always secure to a fastening device using a safety cable. For our CHAUVET Professional line of safety cables, go to <http://trusst.com/products/>.
- When mounting the product on the floor, make sure that the product and cables are away from people and vehicles.
- Place the Maverick MK2 Spot so that it can move freely without hitting anything or anybody.
- Leave enough slack on the cable to prevent tension and pull on the plugs.

Mounting Diagram

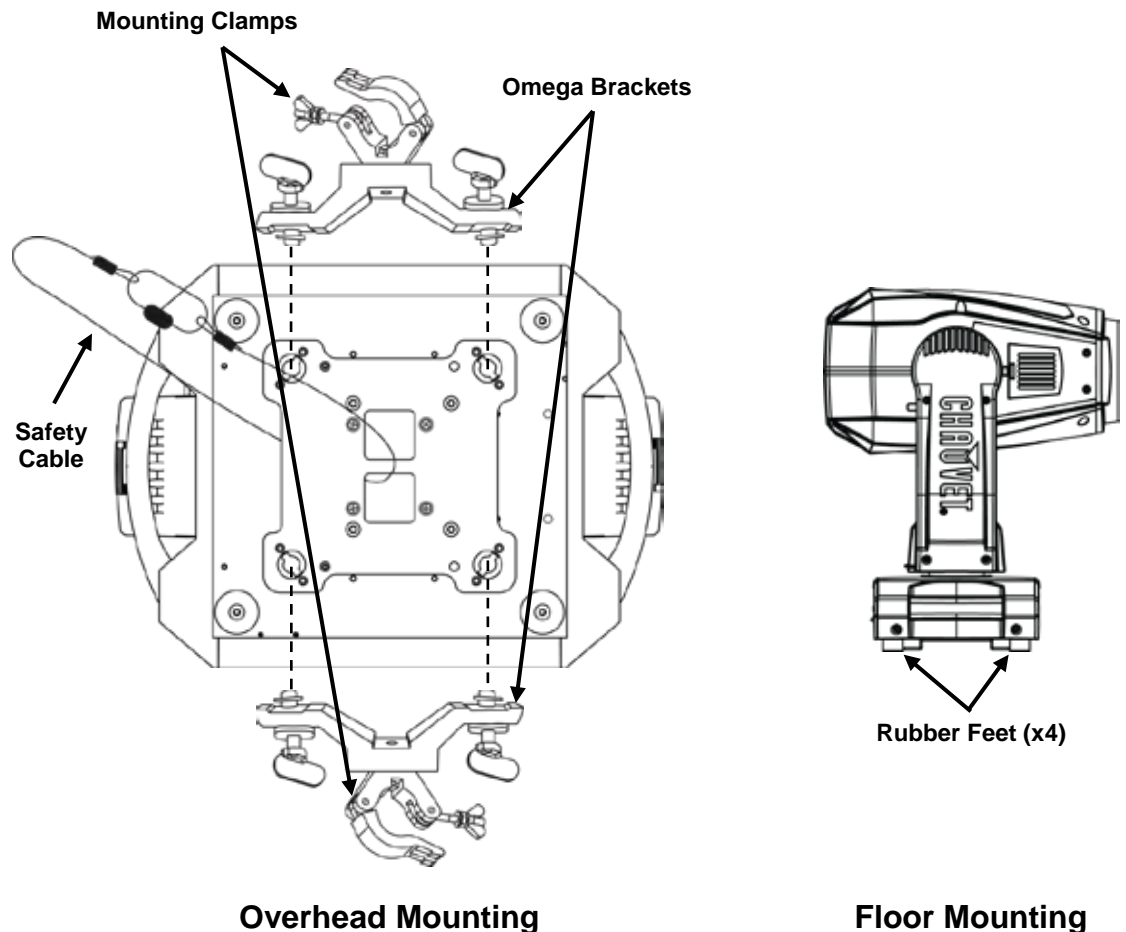

Signal Connections

The Maverick MK2 Spot can receive DMX, sACN or Art-Net™ signals. The Maverick MK2 Spot has 2 etherCON® through ports, and 3- and 5-pin DMX In and Out ports. For more information about DMX, read the DMX primer at:

http://www.chauvetlighting.com/downloads/DMX_Primer_Rev9_ML_WO.pdf

Art-Net™ Connection

Art-Net™ is an Ethernet protocol that uses TCP/IP, which transfers large amounts of DMX512 data using an etherCON® RJ45 connection over a large network. An Art-Net™ protocol document is available from www.chauvetprofessional.com.

Art-Net™ designed by and copyright Artistic Licence Holdings Ltd.



sACN Connection





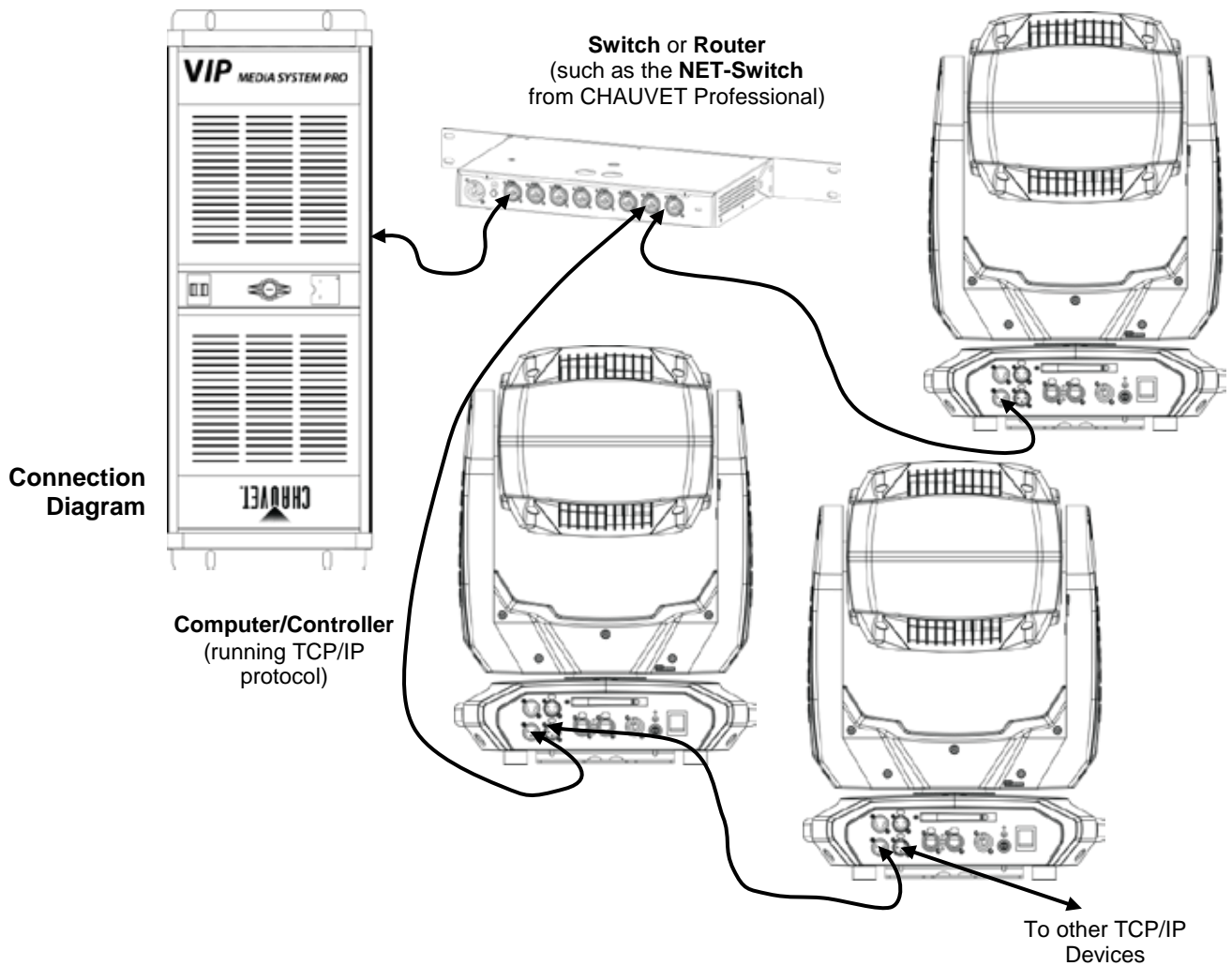

Chauvet Professional recommends using unicast Art-Net™ for best results.

Also known as ANSI E1.31, streaming ACN is an Ethernet protocol that uses the layering and formatting of Architecture for Control Networks to transport DMX512 data over TCP/IP or any other ACN compatible network. ACN is maintained by the Professional Lighting and Sound Association (PLASA).



4. OPERATION

The Maverick MK2 Spot has a touchscreen display as well as 6 control buttons. Navigate the menu structure by pressing the buttons, touching the images of the buttons on the sides of the display, or touching the desired menu option on the display directly. The touchscreen can be locked and calibrated through the Setup options in the menu (see Touchscreen Calibration and Touchscreen Lock).

Touchscreen and Control Panel Description	Button	Function
	 (<UP>)	Navigates upwards through the menu list or increases the numeric value when in a function
	 (<MENU>)	Exits from the current menu or function
	 (<DOWN>)	Navigates downwards through the menu list or decreases the numeric value when in a function
	 (<LEFT>)	Navigates leftwards through the menu list
	 (<ENTER>)	Enables the currently displayed menu or sets the currently selected value into the selected function
	 (<RIGHT>)	Navigates rightwards through the menu list

Menu Map

Main Level	Programming Levels		Description
Address	000-512		Network Setting
Network Setup	Ethernet to DMX	YES	Turn on Art-Net to DMX capability
		NO	
	IP Mode	Manual	Selection of IP mode (Static IP: 2.243.76.222)
		DHCP	
		Static	
	Universe	0 ~ 255	Set the Universe
ArtNetIp	002.243.075.222	IP setting	
SubMask	255.000.000.000	Subnet Mask	
Personality	DMX 24CH	YES	Choose 24 Channels of DMX
		NO	
	DMX 32CH	YES	Choose 32 Channels of DMX
		NO	
Settings	Control Mode	DMX	Signal Selection
		WDMX	
		ArtNet	
		sACN	
	Pan Reverse	YES	Reverse the Pan
		NO	
	Tilt Reverse	YES	Reverse the Tilt
		NO	
	Screen Reverse	NO	Manually or automatically reverse the screen
		YES	
AUTO			

Main Level	Programming Levels		Description
Settings (Continued)	Pan Angle	540	Change the Pan angle
		360	
		180	
	Tilt Angle	270	Change the Tilt angle
		180	
		90	
	BL. O. P/T Move	YES	Enable/disable XY blackout
		NO	
	BL. O. Color Move	YES	Enable/disable color blackout
		NO	
	BL. O. Gobo Move	YES	Enable/disable gobo blackout
		NO	
	Calibration	YES	Turn on Calibration
		NO	
	Touchscreen Lock	YES	Lock the touchscreen
		NO	
	Lock Screen	YES	Lock the buttons and touchscreen PASSCODE: 0920
		NO	
	Swap X/Y	YES	Swap the pan and tilt
		NO	
	X/Y Mode	Fast	Pan and tilt speed
		Slow	
	WDMX Reset	YES	Reset the wireless DMX
		NO	
	Backlight Timer	30S	Set the backlight to turn off automatically after a chosen time
		1M	
		5M	
		ON	
	Loss of Data	Hold	Loss of data setting
		Close	
	Fans	Auto	Change the fan speed mode
		Full	
		ECO	
Dimmer Curve	Linear	Set the dimmer curve	
	Square		
	I Square		
	Scurve		
Dimmer Speed	Smooth	Change the dimmer speed	
	Fast		
Reset Function	Pan/Tilt	YES/NO	Reset individual functions to factory
	Iris/ Prism		
	Color/CMY + CTO		
	Gobo/Gobo Rotate		
	Zoom/Frost/ Focus		
	All		

Main Level	Programming Levels		Description	
	Factory Settings	YES	Reset all functions to factory	
		NO		
Test	Auto Test		Auto test the product	
	Manual Test	Pan	0 ~ 255	Individually test each function/channel
		Pan Fine	0 ~ 255	
		Tilt	0 ~ 255	
		Tilt Fine	0 ~ 255	
		P/T Speed	0 ~ 255	
		Dimmer	0 ~ 255	
		Dimmer Fine	0 ~ 255	
		Shutter	0 ~ 255	
		Virtual Shaking	0 ~ 255	
		Cyan	0 ~ 255	
		Magenta	0 ~ 255	
		Yellow	0 ~ 255	
		CTO	0 ~ 255	
		Color	0 ~ 255	
		Gobo 1	0 ~ 255	
		Gobo 1 Index Fine	0 ~ 255	
		Gobo 1 Rotate	0 ~ 255	
		Gobo 2	0 ~ 255	
		Gobo 2 Index Fine	0 ~ 255	
		Gobo 2 Rotate	0 ~ 255	
		Focus	0 ~ 255	
		Focus Fine	0 ~ 255	
		Focus Auto	0 ~ 255	
		Zoom	0 ~ 255	
		Zoom Fine	0 ~ 255	
		Prism	0 ~ 255	
		Prism Rotate	0 ~ 255	
		Iris	0 ~ 255	
	Frost	0 ~ 255		
CMY Macro	0 ~ 255			
CMY Macro Speed	0 ~ 255			
Special Function	0 ~ 255			

Main Level	Programming Levels		Description	
Information	Fixture Information	Ver	V1	Current Version
		Running Mode	DMX	Current Mode
		DMX Address	001	
		Temperature	025	Current Temperature
		Fixture Hours	00000	Current active hours
		ArtNetIp	002.243.075.222	Current IP address
		SubMask	255.000.000.000	Current subnet mask
		MAC	00.04.a3.08.00.00	MAC address
	Fan Information	Base Fan1 Speed	2000rpm	View speed setting
		Base Fan2 Speed	2000rpm	View speed setting
		Head Fan1 Speed	2000rpm	View speed setting
		Head Fan2 Speed	2000rpm	View speed setting
	Error Information	-----		Will appear on screen
	Channel Information	Frequency	0Hz	Status of individual channel
		Pan	0 ~ 255	
		Pan Fine	0 ~ 255	
		Tilt	0 ~ 255	
		Tilt Fine	0 ~ 255	
		P/T Speed	0 ~ 255	
		Dimmer	0 ~ 255	
		Dimmer Fine	0 ~ 255	
		Shutter	0 ~ 255	
		Virtual Shaking	0 ~ 255	
		Cyan	0 ~ 255	
		Magenta	0 ~ 255	
		Yellow	0 ~ 255	
		CTO	0 ~ 255	
		Color	0 ~ 255	
		Gobo 1	0 ~ 255	
		Gobo 1 Index Fine	0 ~ 255	
		Gobo 1 Rotate	0 ~ 255	
		Gobo 2	0 ~ 255	
		Gobo 2 Index Fine	0 ~ 255	
Gobo 2 Rotate		0 ~ 255		
Focus		0 ~ 255		
Focus Fine		0 ~ 255		
Focus Auto		0 ~ 255		
Zoom		0 ~ 255		
Zoom Fine		0 ~ 255		
Prism		0 ~ 255		
Prism Rotate		0 ~ 255		
Iris	0 ~ 255			
Frost	0 ~ 255			
CMY Macro	0 ~ 255			
CMY Macro Speed	0 ~ 255			
Special Function	0 ~ 255			

Operating Settings Configuration

Home Screen The Maverick MK2 Spot has a home screen that shows the protocol mode, the IP address or DMX address, the DMX personality, and the current product temperature. To see the home screen, press **<MENU>** repeatedly until it appears on the display.

Start Address To set the starting address, set the Control Mode and then follow the instructions below:

1. Press **<MENU>** repeatedly until the Home Screen shows on the display. Press **<ENTER>**.
2. Use **<UP>**, **<DOWN>**, **<LEFT>**, or **<RIGHT>** to select **Start Address**, or touch the display where it says **Start Address**.
3. If using the buttons instead of the touchscreen, press **<ENTER>**.
4. Enter the starting address (**001–512**) with one of the following methods:
 - Type the address number using the number pad that shows on the touchscreen display.
 - or
 - Using the buttons (or the button icons on the sides of the display),
 - a. Use **<LEFT>** or **<RIGHT>** to select the digit to be altered.
 - b. Use **<UP>** or **<DOWN>** to increase or decrease the number value of that digit.
 - c. Repeat until the address is set as desired.
5. Press **<ENTER>**.

Network Setup



The universe of the TCP/IP protocol will be the universe of the DMX function.

Ethernet To DMX The Maverick MK2 Spot can convert a single ethernet input signal to a single DMX output signal. To activate or deactivate the Ethernet to DMX function, do the following:

1. Press **<MENU>** repeatedly until the Home Screen shows on the display. Press **<ENTER>**.
2. Use **<UP>**, **<DOWN>**, **<LEFT>**, or **<RIGHT>** to select **Network Setup**, or touch the display where it says **Network Setup**.
3. If using the buttons instead of the touchscreen, press **<ENTER>**.
4. Use **<UP>** or **<DOWN>** to select **Ethernet to DMX**, or touch the display where it says **Ethernet to DMX**.
5. If using the buttons instead of the touchscreen, press **<ENTER>**.
6. Use **<UP>**, **<DOWN>**, **<LEFT>**, or **<RIGHT>** to select **NO** (deactivate) or **YES** (activate), or touch the display where it says the desired setting.
7. Press **<ENTER>**.

IP Mode The IP address of the Maverick MK2 Spot can be set manually, by the network, or to a pre-set static address specific to each product. To set the IP Mode, follow the instructions below:

1. Press **<MENU>** repeatedly until the Home Screen shows on the display. Press **<ENTER>**.
2. Use **<UP>**, **<DOWN>**, **<LEFT>**, or **<RIGHT>** to select **Network Setup**, or touch the display where it says **Network Setup**.
3. If using the buttons instead of the touchscreen, press **<ENTER>**.
4. Use **<UP>** or **<DOWN>** to select **IP Mode**, or touch the display where it says **IP Mode**.
5. If using the buttons instead of the touchscreen, press **<ENTER>**.
6. Use **<UP>**, **<DOWN>**, **<LEFT>**, or **<RIGHT>** to select from:
 - **Manual** (set the IP address with the control panel),
 - **DHCP** (the network sets the IP address),
 - or
 - **Static** (a pre-set address specific to each product),
 or touch the display where it says the desired mode.
7. Press **<ENTER>**.

Subnet and Universe The Subnet and universe must be assigned through the product menu. To set the Subnet and Universe do the following:

1. Press **<MENU>** repeatedly until the Home Screen shows on the display. Press **<ENTER>**.
2. Use **<UP>**, **<DOWN>**, **<LEFT>**, or **<RIGHT>** to select **Network Setup**, or touch the display where it says **Network Setup**.
3. If using the buttons instead of the touchscreen, press **<ENTER>**.
4. Use **<UP>** or **<DOWN>** to select **Subnet and Universe**, or touch the display where it says **Subnet and Universe**.
5. If using the buttons instead of the touchscreen, press **<ENTER>**.
6. Enter the universe address (**0–254** for **ArtNet**, **0–255** for **sACN**) with one of the following methods:
 - Type the universe number using the number pad that shows on the touchscreen display.
 - or
 - Using the buttons (or the button icons on the sides of the display),
 - a. Use **<LEFT>** or **<RIGHT>** to select the digit to be altered.
 - b. Use **<UP>** or **<DOWN>** to increase or decrease the number value of that digit.
 - c. Repeat until the universe or subnet is set as desired.
7. Press **<ENTER>**.

ArtNet IP Address To set the IP address, do the following:

1. Press **<MENU>** repeatedly until the Home Screen shows on the display. Press **<ENTER>**.
2. Use **<UP>**, **<DOWN>**, **<LEFT>**, or **<RIGHT>** to select **Network Setup**, or touch the display where it says **Network Setup**.
3. If using the buttons instead of the touchscreen, press **<ENTER>**.
4. Use **<UP>** or **<DOWN>** to select **ArtNetIP**, or touch the display where it says **ArtNetIP**.
5. If using the buttons instead of the touchscreen, press **<ENTER>**.
6. Set the IP address (from **000.000.000.000** to **255.255.255.255**) with one of the following methods:
 - Through the touchscreen:
 - a. Touch the display where it shows the byte (set of three numbers) to be changed.
 - b. Use the number pad on the display to enter the desired number.
 - c. Repeat until the IP address is set as desired.
 - With the buttons:
 - a. Use **<LEFT>** or **<RIGHT>** to select the byte (set of three numbers) to be changed).
 - b. Use **<UP>** or **<DOWN>** to increase or decrease the value.
 - c. Repeat until the IP address is set as desired.
7. Press **<ENTER>**.

Subnet Mask To set the Subnet Mask, do the following:

1. Press **<MENU>** repeatedly until the Home Screen shows on the display. Press **<ENTER>**.
2. Use **<UP>**, **<DOWN>**, **<LEFT>**, or **<RIGHT>** to select **Network Setup**, or touch the display where it says **Network Setup**.
3. If using the buttons instead of the touchscreen, press **<ENTER>**.
4. Use **<UP>** or **<DOWN>** to select **SubMask**, or touch the display where it says **SubMask**.
5. If using the buttons instead of the touchscreen, press **<ENTER>**.
6. Set the Subnet Mask (from **000.000.000.000** to **255.255.255.255**) with one of the following methods.
 - Through the touchscreen:
 - a. Touch the display where it shows the byte (set of three numbers) to be changed.
 - b. Use the number pad on the display to enter the desired number.
 - c. Repeat until the Subnet Mask is set as desired.
 - With the buttons:
 - a. Use **<LEFT>** or **<RIGHT>** to select the byte (set of three numbers) to be changed).
 - b. Use **<UP>** or **<DOWN>** to increase or decrease the value.
 - c. Repeat until the Subnet Mask is set as desired.
7. Press **<ENTER>**.



In DHCP or Static IP Mode, the IP and SubMask menu settings have no effect on the product.

Personality

To set which DMX personality to use, do the following:

1. Press **<MENU>** repeatedly until the Home Screen shows on the display. Press **<ENTER>**.
2. Use **<UP>**, **<DOWN>**, **<LEFT>**, or **<RIGHT>** to select **Personality**, or touch the display where it says **Personality**.
3. If using the buttons instead of the touchscreen, press **<ENTER>**.
4. Use **<UP>**, **<DOWN>**, **<LEFT>**, or **<RIGHT>** to select **DMX 24CH** or **DMX 32CH**, or touch the display where it says the desired option.
5. If using the buttons instead of the touchscreen, press **<ENTER>**.
6. Use **<UP>**, **<DOWN>**, **<LEFT>**, or **<RIGHT>** to select **NO** (cancel) or **YES** (confirm) or touch the display where it says the desired option.
7. Press **<ENTER>**.

Settings

To reach the **Settings** menu, follow the instructions below:

1. Press **<MENU>** repeatedly until the Home Screen shows on the display. Press **<ENTER>**.
2. Use **<UP>**, **<DOWN>**, **<LEFT>**, or **<RIGHT>** to select **Settings**, or touch the display where it says **Settings**.
3. If using the buttons instead of the touchscreen, press **<ENTER>**.

Control Mode The Maverick MK2 Spot can be set to respond to DMX, WDMX, Art-Net™ or sACN. The protocol configuration must be set for the product to respond correctly to the controller(s). See the Menu Map for more information.

To configure the protocol for the Maverick MK2 Spot, follow the instructions below:

1. Navigate to the **Settings** menu.
2. Use **<UP>** or **<DOWN>** to select **Control Mode**, or touch the display where it says **Control Mode**.
3. If using the buttons instead of the touchscreen, press **<ENTER>**.
4. Use **<UP>**, **<DOWN>**, **<LEFT>**, or **<RIGHT>** to select **DMX**, **WDMX**, **sACN**, **ArtNet.**, or touch the display where it says the desired option.
5. Press **<ENTER>**.



For WDMX control, ensure the antenna is raised and there are no obstructions between the controller and the product. See WDMX Reset for troubleshooting information.

Pan/Tilt Orientation To set whether the pan or tilt orientation is normal or inverted:"

1. Navigate to the **Settings** menu.
2. Use **<UP>** or **<DOWN>** to select **Pan Reverse** or **Tilt Reverse**, or touch the display where it says the desired setting.
3. If using the buttons instead of the touchscreen, press **<ENTER>**.
4. Use **<UP>**, **<DOWN>**, **<LEFT>**, or **<RIGHT>** to select **NO** (normal orientation) or **YES** (inverted orientation), or touch the display where it says the desired option.
5. Press **<ENTER>**.

Display Orientation To set which way the display faces, do the following:

1. Navigate to the **Settings** menu.
2. Use **<UP>** or **<DOWN>** to select **Screen Reverse**, or touch the display where it says **Screen Reverse**.
3. If using the buttons instead of the touchscreen, press **<ENTER>**.
4. Use **<UP>**, **<DOWN>**, **<LEFT>**, or **<RIGHT>** to select **NO** (display is normal), **YES** (display is inverted), or **AUTO** (the display automatically detects which way the product is facing and orients itself accordingly), or touch the display where it says the desired option.
5. Press **<ENTER>**.

- Pan/Tilt Angle Range** To set the range of motion the pan or tilt is permitted:
1. Navigate to the **Settings** menu.
 2. Use **<UP>** or **<DOWN>** to select **Pan Angle** or **Tilt Angle**, or touch the display where it says the desired setting.
 3. If using the buttons instead of the touchscreen, press **<ENTER>**.
 4. Use **<UP>**, **<DOWN>**, **<LEFT>**, or **<RIGHT>** to select **540** (540°), **360** or **270** (360° or 270° for pan or tilt respectively), **180** (180°), or **90** (90°) or touch the display where it says the desired option.
 5. Press **<ENTER>**.
- Blackout on Pan/Tilt Movement** To set whether the product will black out during pan or tilt movement, follow the instructions below:
1. Navigate to the **Settings** menu.
 2. Use **<UP>** or **<DOWN>** to select **BL. O. P/T Move**, or touch the display where it says **BL. O. P/T Move**.
 3. If using the buttons instead of the touchscreen, press **<ENTER>**.
 4. Use **<UP>**, **<DOWN>**, **<LEFT>**, or **<RIGHT>** to select **NO** (do not black out) or **YES** (black out during movement), or touch the display where it says the desired option.
 5. Press **<ENTER>**.
- Blackout on Color Movement** To set whether the product will black out during color movement, follow the instructions below:
1. Navigate to the **Settings** menu.
 2. Use **<UP>** or **<DOWN>** to select **BL. O. Color Move**, or touch the display where it says **BL. O. Color Move**.
 3. If using the buttons instead of the touchscreen, press **<ENTER>**.
 4. Use **<UP>**, **<DOWN>**, **<LEFT>**, or **<RIGHT>** to select **NO** (do not black out) or **YES** (black out during movement), or touch the display where it says the desired option.
 5. Press **<ENTER>**.
- Blackout on Gobo Movement** To set whether the product will black out during gobo movement, follow the instructions below:
1. Navigate to the **Settings** menu.
 2. Use **<UP>** or **<DOWN>** to select **BL. O. Gobo Move**, or touch the display where it says **BL. O. Gobo Move**.
 3. If using the buttons instead of the touchscreen, press **<ENTER>**.
 4. Use **<UP>**, **<DOWN>**, **<LEFT>**, or **<RIGHT>** to select **NO** (do not black out) or **YES** (black out during movement), or touch the display where it says the desired option.
 5. Press **<ENTER>**.
- Touchscreen Calibration** If the touchscreen is not responding correctly, it may need to be calibrated. To do so:
1. Navigate to the **Settings** menu.
 2. Use **<UP>** or **<DOWN>** to select **Calibration**, or touch the display where it says **Calibration**.
 3. If using the buttons instead of the touchscreen, press **<ENTER>**.
 4. Use **<UP>**, **<DOWN>**, **<LEFT>**, or **<RIGHT>** to select **NO** (do not calibrate) or **YES** (calibrate), or touch the display where it says the desired option.
 5. Press **<ENTER>**.
 6. Follow the instructions, touching the points as they appear on the display.
- Touchscreen Lock** To lock or unlock the touchscreen control panel, do the following:
1. Navigate to the **Settings** menu.
 2. Use **<UP>** or **<DOWN>** to select **Touchscreen Lock**, or touch the display where it says **Touchscreen Lock**.
 3. If using the buttons instead of the touchscreen, press **<ENTER>**.
 4. Use **<UP>**, **<DOWN>**, **<LEFT>**, or **<RIGHT>** to select **NO** (display will respond to touch) or **YES** (display will not respond to touch), or touch the display on the desired option.
 5. Press **<ENTER>**.

Lock the Screen To lock the touchscreen control panel and menu buttons, do the following:

1. Navigate to the **Settings** menu.
2. Use **<UP>** or **<DOWN>** to select **Lock Screen**, or touch the display where it says **Lock Screen**.
3. If using the buttons instead of the touchscreen, press **<ENTER>**.
4. Use **<UP>**, **<DOWN>**, **<LEFT>**, or **<RIGHT>** to select **NO** (display will respond to touch or buttons) or **YES** (display will not respond to touch or buttons), or touch the display where it says the desired option.
5. Press **<ENTER>**.

To unlock the touchscreen and menu buttons, do the following:

1. Touch the display touchscreen anywhere or push any menu button.
2. Enter the passcode (**0920**) using the touchscreen or buttons.

Swap Pan and Tilt To switch the pan and tilt functions so that what normally controls the pan controls the tilt and what normally controls the tilt controls the pan, follow the instructions below:

1. Navigate to the **Settings** menu.
2. Use **<UP>** or **<DOWN>** to select **Swap XY**, or touch the display where it says **Swap XY**.
3. If using the buttons instead of the touchscreen, press **<ENTER>**.
4. Use **<UP>**, **<DOWN>**, **<LEFT>**, or **<RIGHT>** to select **NO** (normal pan and tilt) or **YES** (pan controls tilt, tilt controls pan), or touch the display where it says the desired option.
5. Press **<ENTER>**.

Pan/Tilt Speed To set the maximum speed of the pan and tilt:

1. Navigate to the **Settings** menu.
2. Use **<UP>** or **<DOWN>** to select **XY Mode**, or touch the display where it says **XY Mode**.
3. If using the buttons instead of the touchscreen, press **<ENTER>**.
4. Use **<UP>**, **<DOWN>**, **<LEFT>**, or **<RIGHT>** to select **Slow** or **Fast**, or touch the display where it says the desired option.
5. Press **<ENTER>**.

WDMX Reset To reset the WDMX connection from the Maverick MK2 Spot, do the following:

1. Navigate to the **Settings** menu.
2. Use **<UP>** or **<DOWN>** to select **WDMX Reset**, or touch the display where it says **WDMX Reset**.
3. If using the buttons instead of the touchscreen, press **<ENTER>**.
4. Use **<UP>**, **<DOWN>**, **<LEFT>**, or **<RIGHT>** to select **NO** (do not reset connection) or **YES** (reset the connection), or touch the display where it says the desired option.
5. Press **<ENTER>**.

Backlight Timer To set the amount of time after inactivity before the display backlight turns off:

1. Navigate to the **Settings** menu.
2. Use **<UP>** or **<DOWN>** to select **Backlight Timer**, or touch the display where it says **Backlight Timer**.
3. If using the buttons instead of the touchscreen, press **<ENTER>**.
4. Use **<UP>**, **<DOWN>**, **<LEFT>**, or **<RIGHT>** to select **30S** (after 30 seconds of inactivity), **1M** (after 1 minute of inactivity), **5M** (after 5 minutes of inactivity), or **30M** (after 30 minutes of inactivity), or touch the display where it says the desired option.
5. Press **<ENTER>**.

Loss of Data In case of an input signal being lost in any way, the Maverick MK2 Spot will respond in one of two ways. The product will either hold the last signal received, or black out all LED output.

To set which way the product responds, follow the instructions below:

1. Navigate to the **Settings** menu.
2. Use **<UP>** or **<DOWN>** to select **Loss of Data**, or touch the display where it says **Loss of Data**.
3. If using the buttons instead of the touchscreen, press **<ENTER>**.
4. Use **<UP>**, **<DOWN>**, **<LEFT>**, or **<RIGHT>** to select **Hold** (hold last signal received) or **Close** (black out all LED output), or touch the display where it says the desired option.
5. Press **<ENTER>**.

Fan Speed To set the speed of the fans, do the following:

1. Navigate to the **Settings** menu.
2. Use **<UP>** or **<DOWN>** to select **Fans**, or touch the display where it says **Fans**.
3. If using the buttons instead of the touchscreen, press **<ENTER>**.
4. Use **<UP>**, **<DOWN>**, **<LEFT>**, or **<RIGHT>** to select **Auto** (fan speed set according to product temperature), **Full** (maximum speed), or **ECO** (quiet fans mode), or touch the display where it says the desired option.
5. Press **<ENTER>**.

Dimmer Curve To set the dimmer curve, follow the instructions below:

1. Navigate to the **Settings** menu.
2. Use **<UP>** or **<DOWN>** to select **Dimmer Curve**, or touch the display where it says **Dimmer Curve**.
3. If using the buttons instead of the touchscreen, press **<ENTER>**.
4. Use **<UP>**, **<DOWN>**, **<LEFT>**, or **<RIGHT>** to select **Linear**, **Square**, **I Squa**, or **SCurve**, or touch the display where it says the desired option.
5. Press **<ENTER>**.

Dimmer Speed To set the dimmer speed, do the following:

1. Navigate to the **Settings** menu.
2. Use **<UP>** or **<DOWN>** to select **Dimmer Speed**, or touch the display where it says **Dimmer Speed**.
3. If using the buttons instead of the touchscreen, press **<ENTER>**.
4. Use **<UP>**, **<DOWN>**, **<LEFT>**, or **<RIGHT>** to select **Smooth** or **Fast**, or touch the display where it says the desired option.
5. Press **<ENTER>**.

Reset Functions To reset the pan, tilt, or all functions as if from startup:

1. Navigate to the **Settings** menu.
2. Use **<UP>** or **<DOWN>** to select **Reset Function**, or touch the display where it says **Reset Function**.
3. If using the buttons instead of the touchscreen, press **<ENTER>**.
4. Use **<UP>** or **<DOWN>** to select the function to reset, from **Pan/Tilt**, **Iris/Prism**, **Color/CMY+CTO**, **Gobo/Gobo Rotate**, **Zoom/Frost/Focus** or **All**, or touch the display where it says the desired option.
5. If using the buttons instead of the touchscreen, press **<ENTER>**.
6. Use **<UP>**, **<DOWN>**, **<LEFT>**, or **<RIGHT>** to select from **NO** (do not reset) or **YES** (reset), or touch the display where it says the desired option.
7. Press **<ENTER>**.

Factory Reset To restore the Maverick MK2 Spot to factory default settings, do the following:

1. Navigate to the **Settings** menu.
2. Use **<UP>** or **<DOWN>** to select **Factory Settings**, or touch the display where it says **Factory Settings**.
3. If using the buttons instead of the touchscreen, press **<ENTER>**.
4. Use **<UP>**, **<DOWN>**, **<LEFT>**, or **<RIGHT>** to select **NO** (do not reset) or **YES** (reset to factory settings), or touch the display where it says the desired option.
5. Press **<ENTER>**.

Test Mode

Auto Test To perform an auto test of the Maverick MK2 Spot functions, follow the instructions below:

1. Press **<MENU>** repeatedly until the Home Screen shows on the display. Press **<ENTER>**.
2. Use **<UP>**, **<DOWN>**, **<LEFT>**, or **<RIGHT>** to select **Test**, or touch the display where it says **Test**.
3. If using the buttons instead of the touchscreen, press **<ENTER>**.
4. Use **<UP>** or **<DOWN>** to select **Auto test**, or touch the display where it says **Auto test**.
5. Press **<ENTER>**.

Manual Test To test the functions of the product manually, do the following:

1. Press **<MENU>** repeatedly until the Home Screen shows on the display. Press **<ENTER>**.
2. Use **<UP>**, **<DOWN>**, **<LEFT>**, or **<RIGHT>** to select **Test**, or touch the display where it says **Test**.
3. If using the buttons instead of the touchscreen, press **<ENTER>**.
4. Use **<UP>** or **<DOWN>** to select **Manual test**, or touch the display where it says **Manual test**.
5. If using the buttons instead of the touchscreen, press **<ENTER>**.
6. Use **<UP>** or **<DOWN>** to select the function to test, from **Pan, Pan Fine, Tilt, Tilt Fine, P/S Speed, Dimmer, Dimmer Fine, Shutter, Virtual Shaking, Cyan, Magenta, Yellow, CTO, Color, Gobo, Gobo Rotate, Gobo 2, Gobo 2 Rotate, Focus, Focus Fine, Focus Auto, Zoom, Zoom Fine, Prism, Prism Rotate, Iris, Frost, CMY Macro, CMY Macro Speed, or Special Function**, or touch the display where it says the desired function.
7. If using the buttons instead of the touchscreen, press **<ENTER>**.
8. Change the value of the tested function with one of the following methods:
 - Type the desired value using the number pad that shows on the touchscreen display.
or
 - Use **<UP>**, **<RIGHT>**, **<DOWN>**, or **<LEFT>** to increase or decrease the value.
9. Press **<ENTER>**.

System Information

All information about the current status of the Maverick MK2 Spot is available through the product's **Sys Info** menu. To view this information, follow the instructions below:

1. Press **<MENU>** repeatedly until the Home Screen shows on the display. Press **<ENTER>**.
2. Use **<UP>**, **<DOWN>**, **<LEFT>**, or **<RIGHT>** to select **Information**, or touch the display where it says **Information**.
3. If using the buttons instead of the touchscreen, press **<ENTER>**.
4. Use **<UP>** or **<DOWN>** to select from **Fixture Information** (shows firmware version, running mode, starting address, etc.), **Fan Information** (shows speed of the head fans in rpm), **Error Information** (shows any errors or No Error!), or **Channel Information** (shows the current value of all signal input channels) or touch the display where it says the desired option.
5. Press **<ENTER>**.
6. Use **<UP>** or **<DOWN>** to scroll through the information.

Offset Mode The Offset mode provides fine adjustments for the home position of all the moving parts in the optical path as well as the pan and tilt movements. This way, when in their home position, the moving parts do not show any border or reduce the light output.

1. Starting from the Main Level screen, press and hold **<MENU>** until the passcode screen appears.
2. Enter the passcode **2323** using one of the following methods:
 - Through the touchscreen: use the number pad on the screen to enter **2323**.
 - With the buttons:
 - d. Use **<DOWN>** to select the number to be changed.
 - e. Use **<UP>** to increase the value.
 - f. Repeat until **2323** has been entered.
3. Press **<ENTER>**.

This brings you into the Zero Adjust menu screen.

- PAN**
1. Use **<UP>** or **<DOWN>** to select **PAN**.
 2. Press **<ENTER>**.
 3. Use **<UP>** or **<DOWN>** to increase or decrease the starting value, from **000–255**.
 4. Press **<ENTER>**.

- TILT**
1. Use **<UP>** or **<DOWN>** to select **TILT**.
 2. Press **<ENTER>**.
 3. Use **<UP>** or **<DOWN>** to increase or decrease the starting value, from **000–255**.
 4. Press **<ENTER>**.

- COLOR**
1. Use **<UP>** or **<DOWN>** to select **COLOR**.
 2. Press **<ENTER>**.
 3. Use **<UP>** or **<DOWN>** to increase or decrease the starting value, from **000–255**.
 4. Press **<ENTER>**.

- GOBO**
1. Use **<UP>** or **<DOWN>** to select **GOBO**.
 2. Press **<ENTER>**.
 3. Use **<UP>** or **<DOWN>** to increase or decrease the starting value, from **000–255**.
 4. Press **<ENTER>**.

- GOBO ROTATE**
1. Use **<UP>** or **<DOWN>** to select **GOBO ROTATE**.
 2. Press **<ENTER>**.
 3. Use **<UP>** or **<DOWN>** to increase or decrease the starting value, from **000–255**.
 4. Press **<ENTER>**.

- GOBO 2**
1. Use **<UP>** or **<DOWN>** to select **GOBO 2**.
 2. Press **<ENTER>**.
 3. Use **<UP>** or **<DOWN>** to increase or decrease the starting value, from **000–255**.
 4. Press **<ENTER>**.

- GOBO 2 ROTATE**
1. Use **<UP>** or **<DOWN>** to select **GOBO 2 ROTATE**.
 2. Press **<ENTER>**.
 3. Use **<UP>** or **<DOWN>** to increase or decrease the starting value, from **000–255**.
 4. Press **<ENTER>**.

- FOCUS 1**
1. Use **<UP>** or **<DOWN>** to select **FOCUS 1**.
 2. Press **<ENTER>**.
 3. Use **<UP>** or **<DOWN>** to increase or decrease the starting value, from **000–255**.
 4. Press **<ENTER>**.

- FOCUS 2**
1. Use **<UP>** or **<DOWN>** to select **FOCUS 2**.
 2. Press **<ENTER>**.
 3. Use **<UP>** or **<DOWN>** to increase or decrease the starting value, from **000–255**.
 4. Press **<ENTER>**.

- FOCUS GOBO 2**
1. Use **<UP>** or **<DOWN>** to select **FOCUS GOBO 2**.
 2. Press **<ENTER>**.
 3. Use **<UP>** or **<DOWN>** to increase or decrease the starting value, from **000–255**.
 4. Press **<ENTER>**.

- ZOOM**
 1. Use <UP> or <DOWN> to select **ZOOM**.
 2. Press <ENTER>.
 3. Use <UP> or <DOWN> to increase or decrease the starting value, from **000–255**.
 4. Press <ENTER>.
- PRISM**
 1. Use <UP> or <DOWN> to select **PRISM**.
 2. Press <ENTER>.
 3. Use <UP> or <DOWN> to increase or decrease the starting value, from **000–255**.
 4. Press <ENTER>.
- IRIS**
 1. Use <UP> or <DOWN> to select **IRIS**.
 2. Press <ENTER>.
 3. Use <UP> or <DOWN> to increase or decrease the starting value, from **000–255**.
 4. Press <ENTER>.
- FROST**
 1. Use <UP> or <DOWN> to select **FROST**.
 2. Press <ENTER>.
 3. Use <UP> or <DOWN> to increase or decrease the starting value, from **000–255**.
 4. Press <ENTER>.
- CYAN**
 1. Use <UP> or <DOWN> to select **CYAN**.
 2. Press <ENTER>.
 3. Use <UP> or <DOWN> to increase or decrease the starting value, from **000–255**.
 4. Press <ENTER>.
- MAGENTA**
 1. Use <UP> or <DOWN> to select **MAGENTA**.
 2. Press <ENTER>.
 3. Use <UP> or <DOWN> to increase or decrease the starting value, from **000–255**.
 4. Press <ENTER>.
- YELLOW**
 1. Use <UP> or <DOWN> to select **YELLOW**.
 2. Press <ENTER>.
 3. Use <UP> or <DOWN> to increase or decrease the starting value, from **000–255**.
 4. Press <ENTER>.
- CTO**
 1. Use <UP> or <DOWN> to select **CTO**.
 2. Press <ENTER>.
 3. Use <UP> or <DOWN> to increase or decrease the starting value, from **000–255**.
 4. Press <ENTER>.
- DIMMER**
 1. Use <UP> or <DOWN> to select **DIMMER**.
 2. Press <ENTER>.
 3. Use <UP> or <DOWN> to increase or decrease the starting value, from **000–255**.
 4. Press <ENTER>.
- LED POWER**
 1. Use <UP> or <DOWN> to select **LED POWER**.
 2. Press <ENTER>.
 3. Use <UP> or <DOWN> to increase or decrease the starting value, from **000–255**.
 4. Press <ENTER>.
- MAC4**
 1. Use <UP> or <DOWN> to select **MAC4**.
 2. Press <ENTER>.
 3. Use <UP> or <DOWN> to increase or decrease the starting value, from **000–255**.
 4. Press <ENTER>.
- MAC5**
 1. Use <UP> or <DOWN> to select **MAC5**.
 2. Press <ENTER>.
 3. Use <UP> or <DOWN> to increase or decrease the starting value, from **000–255**.
 4. Press <ENTER>.
- MAC6**
 1. Use <UP> or <DOWN> to select **MAC6**.
 2. Press <ENTER>.
 3. Use <UP> or <DOWN> to increase or decrease the starting value, from **000–255**.
 4. Press <ENTER>.

DMX Values

32CH	Channel	Function	Value	Percent/Settings
	1	Pan	000 ó 255	0–100%
	2	Fine Pan	000 ó 255	0–100%
	3	Tilt	000 ó 255	0–100%
	4	Fine Tilt	000 ó 255	0–100%
	5	Pan/Tilt Speed	000 ó 255	0–100%
	6	Dimmer	000 ó 255	0–100%
	7	Fine Dimmer	000 ó 255	0–100%
	8	Shutter	000 ó 003 004 ó 007 008 ó 076 077 ó 145 146 ó 215 216 ó 255	Closed Open Slow to fast Pulse effect from slow to fast Random effect from slow to fast Open
	9	Virtual Shutter	000 ó 001 002 ó 128 129 ó 255	No function Shaking strobe, slow to fast Fade in/out, slow to fast
	10	Cyan	000 ó 255	0–100%
	11	Magenta	000 ó 255	0–100%
	12	Yellow	000 ó 255	0–100%
	13	CTO	000 ó 255	0–100%
	14	Color Wheel	000 ó 006 007 ó 013 014 ó 020 021 ó 027 028 ó 034 035 ó 041 042 ó 047 048 ó 059 060 ó 187 188 ó 219 220 ó 223 224 ó 255	Open Red Orange Green Blue Magenta Yellow UV Split colors Clockwise color scroll, fast to slow Stop Counter-clockwise color scroll, slow to fast
	15	Gobo Wheel 1 [Gobo Designs]	000 ó 008 009 ó 017 018 ó 026 027 ó 035 036 ó 044 045 ó 053 054 ó 063 064 ó 073 074 ó 082 083 ó 091 092 ó 100 101 ó 109 110 ó 118 119 ó 127 128 ó 191 192 ó 255	Open Gobo 1 (circuits) Gobo 2 (ring of rings) Gobo 3 (checker vortex) Gobo 4 (triangle) Gobo 5 (star field) Gobo 6 (lenticular glass) Gobo 6 Shaking Gobo 5 Shaking Gobo 4 Shaking Gobo 3 Shaking Gobo 2 Shaking Gobo 1 Shaking Open Clockwise gobo scroll, fast to slow Counter-clockwise gobo scroll, slow to fast
	16	Gobo Rotating 1	000 ó 063 064 ó 145 146 ó 149 150 ó 231 232 ó 255	Rotating Gobo Index Clockwise rotating, fast to slow Stop Counter-clockwise rotating, slow to fast Bounce effect

32CH	Channel	Function	Value	Percent/Settings
	17	Gobo Wheel 1 Index Fine	000ó 255	0–100%
	18	Gobo Wheel 2 [Gobo Designs]	000ó 008 009ó 017 018ó 026 027ó 035 036ó 044 045ó 053 054ó 063 064ó 073 074ó 082 083ó 091 092ó 100 101ó 109 110ó 118 119ó 127 128ó 191 192ó 255	Open Gobo 1 (spiral) Gobo 2 (dot chiclets) Gobo 3 (splat breakup) Gobo 4 (wavy bar) Gobo 5 (shower glass) Gobo 6 (lenticular glass) Gobo 6 Shaking Gobo 5 Shaking Gobo 4 Shaking Gobo 3 Shaking Gobo 2 Shaking Gobo 1 Shaking Open Clockwise gobo scroll, fast to slow Counter-clockwise gobo scroll, slow to fast
	19	Gobo Rotating 2	000ó 063 064ó 145 146ó 149 150ó 231 232ó 255	Rotating Gobo Index Clockwise rotating, fast to slow Stop Counter-clockwise rotating, slow to fast Bounce effect
	20	Gobo Wheel 2 Index Fine	000ó 255	0–100%
	21	Focus	000ó 255	0–100%
	22	Fine Focus	000ó 255	0–100%
	23	Auto Focus	000ó 010 011ó 030 031ó 050 051ó 070 071ó 090 091ó 110 111ó 130 131ó 150 151ó 170 171ó 190 191ó 210 211ó 255	No Function 0-5m 6m 7m 8m 9m 10m 12.5m 15m 17.5m 20-60m Auto-detect distance
	24	Zoom	000ó 255	0–100%
	25	Fine Zoom	000ó 255	0–100%
	26	Prism	000ó 004 005ó 255	No Function Prism Effect
	27	Prism Rotate	000ó 127 128ó 189 190ó 193 194ó 255	Rotating position Clockwise rotating, slow to fast Stop Counter-clockwise rotating, fast to slow
	28	Iris	000ó 063 064ó 127 128ó 191 192ó 255	Big to small Auto change, slow to fast Slow zoom in, fast zoom out (slow to fast) Slow zoom out, fast zoom in (slow to fast)
	29	Frost	000ó 255	0–100%
	30	CMY Macro	000ó 009 010ó 255	No function CMY macro
	31	CMY Macro Speed	000ó 255	fast to slow

32CH	Channel	Function	Value	Percent/Settings
	32	Control	000◊ 007	No function
			008◊ 015	XY blackout
			016◊ 023	C blackout
			024◊ 031	G blackout
			032◊ 039	XYC blackout
			040◊ 047	XYG blackout
			048◊ 055	XYCG blackout
			056◊ 095	no function
			096◊ 103	X reset
			104◊ 111	Y reset
			112◊ 119	Color reset
			120◊ 127	Gobo & gobo rotating reset
			128◊ 135	no function
			136◊ 143	Prism reset
			144◊ 151	Focus reset
			152◊ 159	All reset
			160◊ 167	Iris reset
			168◊ 175	Frost reset
			176◊ 183	Zoom reset
			184◊ 191	CMY+CTO reset
			192◊ 199	Fan low speed
			200◊ 207	Fan full speed
			208◊ 215	Fan auto
			216◊ 220	no function
			221◊ 225	Iris Fast mode
	226◊ 230	Iris Smooth mode		
	231◊ 235	XY swap on		
	236◊ 240	XY swap off		
	241◊ 245	no function		
	246◊ 250	XY smooth mode		
	251◊ 255	XY fast mode		

24CH	Channel	Function	Value	Percent/Settings
	1	Pan	000◊ 255	0–100%
	2	Fine Pan	000◊ 255	0–100%
	3	Tilt	000◊ 255	0–100%
	4	Fine Tilt	000◊ 255	0–100%
	5	Pan/Tilt Speed	000◊ 255	0–100%
	6	Dimmer	000◊ 255	0–100%
	7	Shutter	000◊ 003	Closed
			004◊ 007	Open
			008◊ 076	Slow to fast
			077◊ 145	Pulse effect from slow to fast
			146◊ 215	Random effect from slow to fast
	216◊ 255	Open		
	8	Virtual Shutter	000◊ 001	No function
			002◊ 128	Shaking strobe, slow to fast
			129◊ 255	Fade in/out, slow to fast
	9	Cyan	000◊ 255	0–100%
	10	Magenta	000◊ 255	0–100%
	11	Yellow	000◊ 255	0–100%
	12	CTO	000◊ 255	0–100%

24CH	Channel	Function	Value	Percent/Settings
	13	Color Wheel	000◊ 006 007◊ 013 014◊ 020 021◊ 027 028◊ 034 035◊ 041 042◊ 047 048◊ 059 060◊ 187 188◊ 219 220◊ 223 224◊ 255	Open Red Orange Green Blue Magenta Yellow UV Split colors Clockwise color scroll, fast to slow Stop Counter-clockwise color scroll, slow to fast
	14	Gobo Wheel 1 [Gobo Designs]	000◊ 008 009◊ 017 018◊ 026 027◊ 035 036◊ 044 045◊ 053 054◊ 063 064◊ 073 074◊ 082 083◊ 091 092◊ 100 101◊ 109 110◊ 118 119◊ 127 128◊ 191 192◊ 255	Open Gobo 1 (circuits) Gobo 2 (ring of rings) Gobo 3 (checker vortex) Gobo 4 (triangle) Gobo 5 (star field) Gobo 6 (lenticular glass) Gobo 6 Shaking Gobo 5 Shaking Gobo 4 Shaking Gobo 3 Shaking Gobo 2 Shaking Gobo 1 Shaking Open Clockwise gobo scroll, fast to slow Counter-clockwise gobo scroll, slow to fast
	15	Gobo Rotating 1	000◊ 063 064◊ 145 146◊ 149 150◊ 231 232◊ 255	Rotating Gobo Index Clockwise rotating, fast to slow Stop Counter-clockwise rotating, slow to fast Bounce effect
	16	Gobo Wheel 2 [Gobo Designs]	000◊ 008 009◊ 017 018◊ 026 027◊ 035 036◊ 044 045◊ 053 054◊ 063 064◊ 073 074◊ 082 083◊ 091 092◊ 100 101◊ 109 110◊ 118 119◊ 127 128◊ 191 192◊ 255	Open Gobo 1 (spiral) Gobo 2 (dot chiclets) Gobo 3 (splat breakup) Gobo 4 (wavy bar) Gobo 5 (shower glass) Gobo 6 (lenticular glass) Gobo 6 Shaking Gobo 5 Shaking Gobo 4 Shaking Gobo 3 Shaking Gobo 2 Shaking Gobo 1 Shaking Open Clockwise gobo scroll, fast to slow Counter-clockwise gobo scroll, slow to fast
	17	Gobo Rotating 2	000◊ 063 064◊ 145 146◊ 149 150◊ 231 232◊ 255	Rotating Gobo Index Clockwise rotating, fast to slow Stop Counter-clockwise rotating, slow to fast Bounce effect
	18	Focus	000◊ 255	0–100%
	19	Zoom	000◊ 255	0–100%
	20	Prism	000◊ 004 005◊ 255	No function Prism effect

24CH	Channel	Function	Value	Percent/Settings
	21	Prism Rotate	000 ó 127 128 ó 189 190 ó 193 194 ó 255	Rotating position Clockwise rotating, slow to fast Stop Counter-clockwise rotating, fast to slow
	22	Iris	000 ó 063 064 ó 127 128 ó 191 192 ó 255	Big to small Auto change, slow to fast Slow zoom in, fast zoom out (slow to fast) Slow zoom out, fast zoom in (slow to fast)
	23	Frost	000 ó 255	0–100%
	24	Control	000 ó 007 008 ó 015 016 ó 023 024 ó 031 032 ó 039 040 ó 047 048 ó 055 056 ó 095 096 ó 103 104 ó 111 112 ó 119 120 ó 127 128 ó 135 136 ó 143 144 ó 151 152 ó 159 160 ó 167 168 ó 175 176 ó 183 184 ó 191 192 ó 199 200 ó 207 208 ó 215 216 ó 220 221 ó 225 226 ó 230 231 ó 235 236 ó 240 241 ó 245 246 ó 250 251 ó 255	No function XY blackout C blackout G blackout XYC blackout XYG blackout XYCG blackout no function X reset Y reset Color reset Gobo & gobo rotating reset no function Prism reset Focus reset All reset Iris reset Frost reset Zoom reset CMY+CTO reset Fan low speed Fan full speed Fan auto no function Iris Fast mode Iris Smooth mode XY swap on XY swap off no function XY smooth mode XY fast mode

Gobo Designs

Wheel 1						
	Circuits	Ring of Rings	Checker Vortex	Triangle	Star Field	Lenticular Glass
Wheel 2						
	Spiral	Dot Chiclets	Spot Breakup	Wavy Bar	Shower Glass	Lenticular Glass

Color Wheel

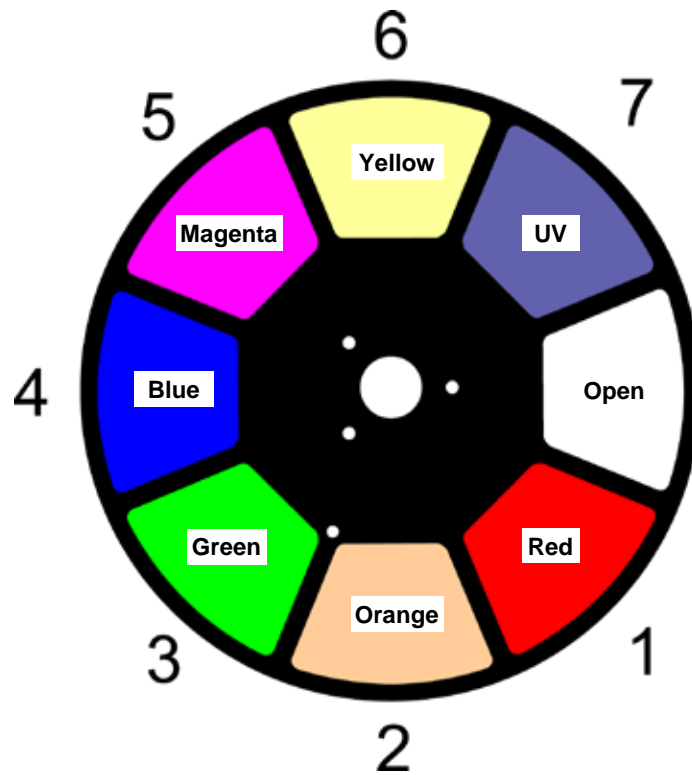

Gobo Replacement

The gobos in both gobo wheels 1 and 2 are removable from their gobo holders. This operation is quite simple, although it requires the technician to be careful and to follow the recommended procedure.



- **Make sure to disconnect the product's power cord before replacing a gobo**
- **Always replace a gobo with a gobo of the same dimensions.**
- **Use only glass gobos when using custom gobos in gobo wheel 2.**
- **When inserting a glass gobo, always make sure that the shiny side of the gobo (glass base) faces the lamp. This provides a layer of protection against the high temperature from the lamp.**

Procedure

1. Turn the product off and disconnect it from the power outlet.
2. Open the head cover by loosening the 4 Phillips-head ¼-turn screws on the sides of the top cover.
3. Separate the gobo holder away from the gobo wheel by pushing it toward the front of the moving head (direction 1 in the diagram). Be careful not to push the gobo out of the gobo holder.
4. Extract the gobo holder by pulling it outward (direction 2 in the diagram).
5. On a flat surface, remove the expansion ring that holds the gobo in place and remove the gobo from the gobo holder.
6. Insert a new gobo and hold it in place with the expansion ring.
7. Slide the tip of the gobo holder under the pressure plate near the center of the gobo wheel.
8. Push the gobo holder inwards. **DO NOT** force the gobo holder into the gobo wheel slot. If correctly installed, the gobo holder should easily slide itself into the gobo wheel slot.

Gobo Wheel 1

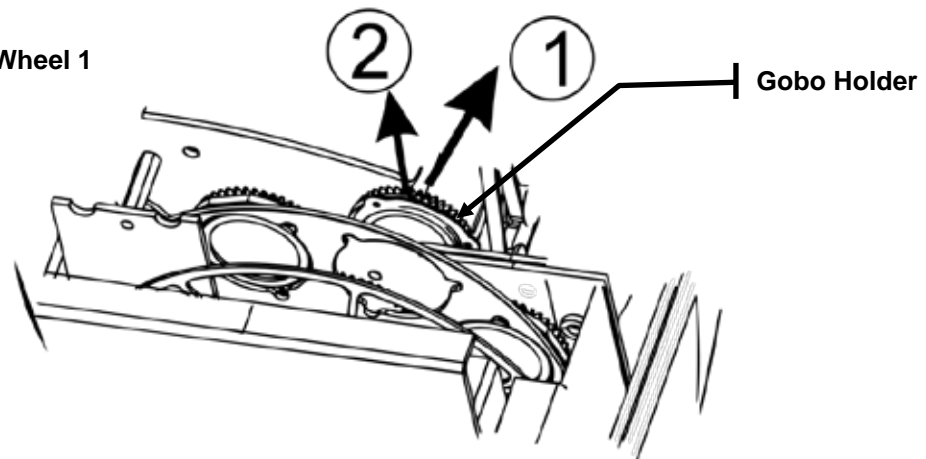

Gobo Replacement Diagrams

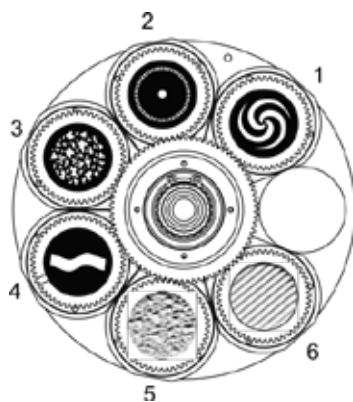

Gobo Wheel 1

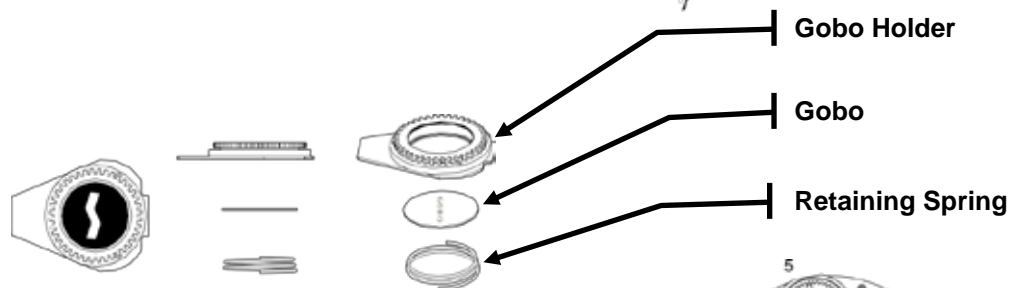

Gobo Wheel 2: Gobo Wheel 2 can be accessed from below Gobo Wheel 1. Remove the lower access panel.

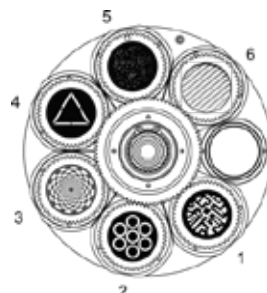

5. FIRMWARE UPDATE

The following steps apply to the Windows® 7 operating system:

- Step 1**
1. Connect the Maverick MK1 Hybrid to a computer with an ethernet cable.
 2. Verify the network with the Maverick MK1 Hybrid is connected to the computer.

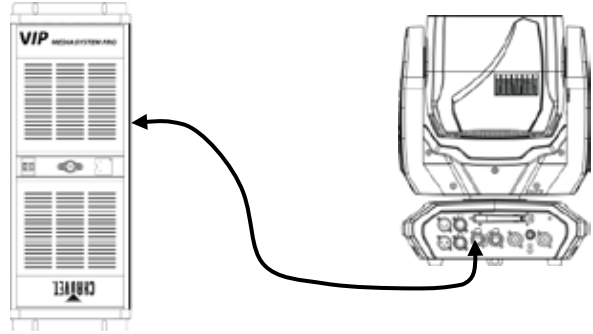

- Step 2**
1. Set the control protocol on the Maverick MK1 Hybrid to **ArtNet** in **Single Control** mode. (See [Single Control Protocol](#))
 2. Set the **IP Mode** to **Static**. (See [IP Mode](#))

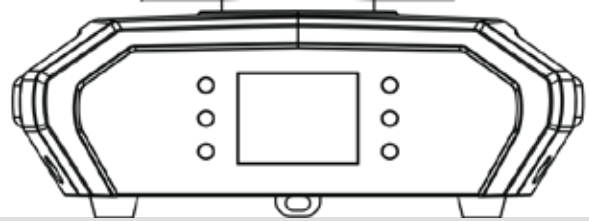

- Step 3**
- On the computer, open the Network and Sharing Center (through the Start Menu, the Control Panel, or the Network icon on the right side of the Taskbar).

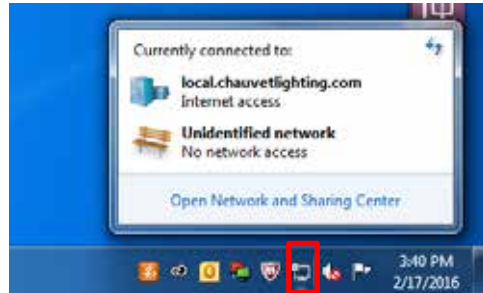

- Step 4**
- Select the network that the product is connected to by clicking the blue text that corresponds to that network on the right side of the window.

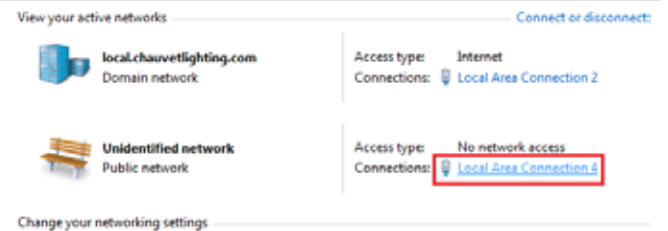

Step 5 Click **Properties** on the **Status** window that pops up.

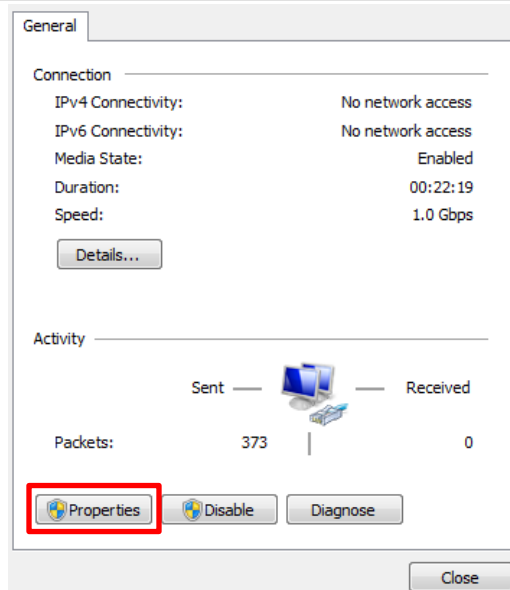

Step 6 On the **Properties** window:

1. Click on **Internet Protocol Version 4 (TCP/IPv4)** to select it.
2. Click **Properties**.

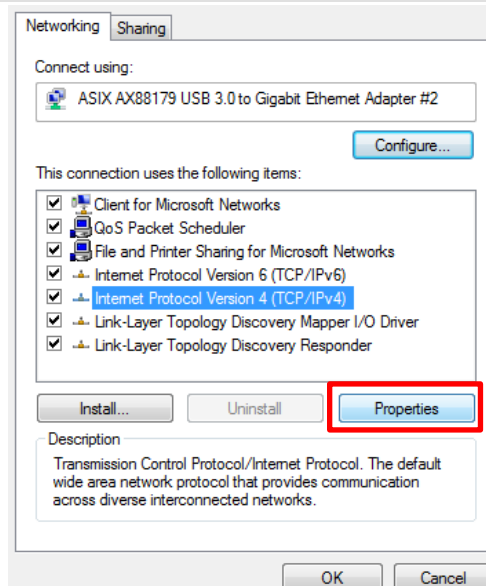

Step 7 On the **TCP/IPv4 Properties** window:

1. Select **Use the following IP address**:
2. Type **2.255.0.0** into the **IP address** bar.
3. Press **<Tab>** on your keyboard. The **Subnet mask** bar should automatically populate as **255.0.0.0**. If not, then enter it manually.
4. Ignore the **Default gateway** bar.

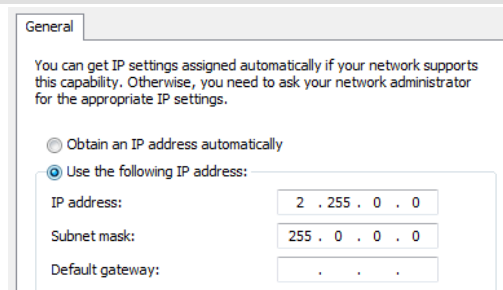

- Step 8**
5. View the Home Screen on the Maverick MK1 Hybrid. (see [Home Screen](#))
 6. Open the internet browser on the computer.
 7. Enter the IP address from the Maverick MK1 Hybrid display into the URL bar of the internet browser. (For example, if the display of the product reads **2.11.0.1**, enter **2.11.0.1** into the URL bar of the internet browser.)

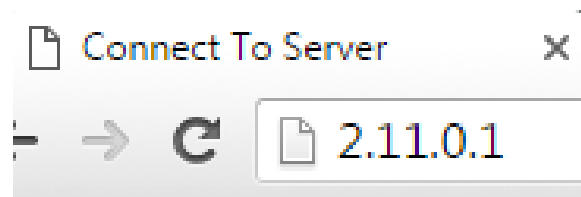

- Step 9** On the **Welcome** screen:
8. Enter **admin** as both the **User Name** and **Password**. No capital letters.
 9. Press **Log In** on the screen, or **<Enter>** on the keyboard.
- If the user name and password do not work, reset the product to factory defaults. (see [Factory Reset](#))

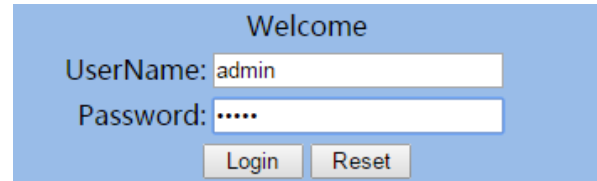

- Step 10** On the page that appears, click **Upgrade**.

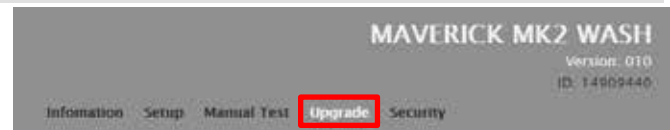

- Step 11** Find the latest Firmware Upgrade on the website at <https://www.chauvetprofessional.com/products/maverick-mk2-wash> under **DOWNLOADS**.



- Step 12**
10. Click **Choose File** on the Maverick MK1 Hybrid Upgrade page.
 11. In the File Explorer window that pops up, select the Firmware Upgrade file from the website and click **Open**.
 12. Click **Upload File**.
- A **Downloading** message will appear on the product's display. Once the product finishes installing the firmware, it will reset.
Do NOT turn the product off during this process.

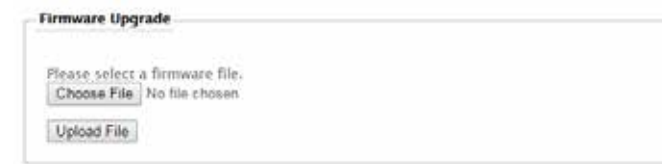

- Step 13** On the Maverick MK1 Hybrid, verify the firmware has been updated by navigating to **Sys Info** ([System Information](#)) and checking that the version number matches the name of the file on the computer.

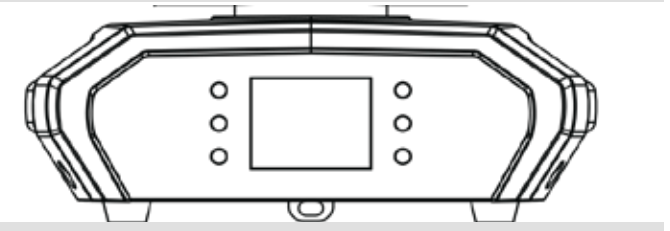

- Step 15** Disconnect the Maverick MK1 Hybrid from the computer. The firmware update is complete.



The examples shown are for illustrative purposes.

6. TECHNICAL INFORMATION

Product Maintenance

To maintain optimum performance and minimize wear, clean this product frequently. Usage and environment are contributing factors in determining the cleaning frequency.

As a rule, clean this product at least twice a month. Dust build-up reduces light output performance and can cause overheating. This can lead to reduced light source life and increased mechanical wear.

To clean your product:

1. Unplug the product from power.
2. Wait until the product is at room temperature.
3. Use a vacuum (or dry compressed air) and a soft brush to remove dust collected on the external vents.
4. Clean all external surfaces with a mild solution of non-ammonia glass cleaner or isopropyl alcohol.
5. Apply the solution directly to a soft, lint-free cotton cloth or a lens cleaning tissue.
6. Wipe any dirt or grime to the outside edges of the lens surface.
7. Gently polish the lens surfaces until they are free of haze and lint.



Always dry the external surfaces thoroughly and carefully after cleaning them.



Do not spin the cooling fans by blowing compressed air into them.

Error Indication

Indicator	Meaning
Focus	Focus error detected
Zoom	Zoom error detected
Prism	Prism error detected
Prism.R	Rotating prism error detected
Gobo	Gobo wheel 1 error detected
Gobo.R	Rotating gobo wheel 1 error detected
Gobo2	Gobo wheel 2 error detected
Gobo2.R	Rotating Gobo wheel 2 error detected
Color	Color error detected
Iris	Iris error detected
CYAN	Cyan error detected
MAGENTA	Magenta error detected
YELLOW	Yellow error detected
CTO	CTO error detected
X_cm1	Pan magnetic sensor 1 error detected
X_cm2	Pan magnetic sensor 2 error detected
X_op	Pan optocoupler error

Indicator	Meaning
Y_cm	Tilt magnetic sensor error
Y_op	Tilt optocoupler error
CPU_A	IC-A error
CPU_B	IC-B error
CPU_C	IC-C error
CPU_D	IC-D error
CPU_E	IC-E error
Head Fan1	Head fan 2 error detected
Head Fan2	Head fan 2 error detected
Base Fan1	Base fan 1 error detected
Base Fan2	Base fan 2 error detected

7. TECHNICAL SPECIFICATIONS

Dimensions and Weight	Length	Width	Height	Weight
	15.1 in (385 mm)	9.8 in (250 mm)	26.4 in (671 mm)	62.8 lb (28.5 kg)
Note: Dimensions in inches rounded to the nearest decimal digit.				
Electrical	Power Supply Type	Range		Voltage Selection
	Switching (internal)	100–240 VAC, 50/60 Hz		Auto-ranging
	Parameter	120 VAC, 60 Hz	208 VAC, 60 Hz	230 VAC, 50 Hz
	Consumption	740 W	723 W	700 W
	Current	6.01 A	3.63 A	3.33 A
	Fuse/Breaker	F 10 A, 250 V	F 10 A, 250 V	F 10 A, 250 V
	Power I/O	U.S./Canada		Worldwide
Power input connector	True 1 compatible		True 1 compatible	
Power cord plug	Edison (U.S.)		Local plug	
Light Source	Type	Power		Lifespan
	LED	440 W		50,000 hours
	Color	Quantity		Current
	CW (cold white)	1		5.6 A
Photo Optic	Parameter	Value		
	Illuminance (13°) @ 5 m	18,079 lux		
	Illuminance (37°) @ 5 m	2,518 lux		
	Beam Angle	12° to 35°		
	Field Angle	13° to 37°		
	Zoom Angle	13° to 37°		
	Color Temperature	6,808 K		
	CRI	73		
	Strobe Rate	0 to 20 Hz		
DMX	I/O Connector	Channel Range		
	3- and 5-pin XLR	24 or 32		
Art-Net™/ sACN	I/O Connector	Channel Range		
	etherCON®	24 or 32		
Thermal	Max. External Temperature	Cooling System		
	113 °F (45 °C)	Fan-Assisted Convection		
Ordering	Product Name	Item Name	Item Code	UPC Number
	Maverick MK2 Spot	MAVERICKMK2SPOT	08011154	781462215026

RETURNS

To get support or return a product:

- If you are located in the U.S., contact Chauvet World Headquarters.
- If you are located in the UK or Ireland, contact Chauvet Europe Ltd.
- If you are located in Mexico, contact Chauvet Mexico.
- If you are located in Benelux, contact Chauvet Europe BVBA.

If you are located in any other country, DO NOT contact Chauvet. Instead, contact your local distributor. See www.chauvetlighting.com for distributors outside the U.S., UK, Ireland, Mexico, or Benelux.



If you are located outside the U.S., UK, Ireland, Mexico, or Benelux, contact your distributor of record and follow their instructions on how to return Chauvet products to them. Visit our website www.chauvetlighting.com for contact details.

Call the corresponding Chauvet Technical Support office and request a Return Merchandise Authorization (RMA) number before shipping the product. Be prepared to provide the model number, serial number, and a brief description of the cause for the return.

Send the merchandise prepaid, in its original box, and with its original packing and accessories. Chauvet will not issue call tags.

Clearly label the package with the RMA number. Chauvet will refuse any product returned without an RMA number.



Write the RMA number on a properly affixed label. DO NOT write the RMA number directly on the box.

Before sending the product, clearly write the following information on a piece of paper and place it inside the box:

- Your name
- Your address
- Your phone number
- RMA number
- A brief description of the problem

Be sure to pack the product properly. Any shipping damage resulting from inadequate packaging will be your responsibility. FedEx packing or double-boxing are recommended.



Chauvet reserves the right to use its own discretion to repair or replace returned product(s).

CONTACT Us

WORLD HEADQUARTERS

General Information

Address: 5200 NW 108th Avenue
Sunrise, FL 33351
Voice: (954) 577-4455
Fax: (954) 929-5560
Toll free: (800) 762-1084

Technical Support

Voice: (844) 393-7575
Fax: (954) 756-8015
Email: Chauvetcs@chauvetlighting.com

World Wide Web www.chauvetlighting.com

EUROPE

General Information

Address: Stokstraat 18
9770 Kruishoutem
Belgium
Voice: +32 9 388 93 97

Technical Support

Email: Eutech@chauvetlighting.eu

World Wide Web www.chauvetlighting.eu

General Information

Address: Unit 1C
Brookhill Road Industrial Estate
Pinxton, Nottingham, UK
NG16 6NT
Voice: +44 (0)1773 511115
Fax: +44 (0)1773 511110

Technical Support

Email: uktech@chauvetlighting.com

World Wide Web www.chauvetlighting.co.uk

MEXICO

General Information

Address: Av. de las Partidas 34-3B
Zona Industrial Lerma
Lerma, Mexico C.P. 52000
Voice: +52 (728) 285-5000

Technical Support

Email: servicio@chauvet.com.mx

World Wide Web www.chauvet.com.mx

Visit the applicable website above to verify our contact information and instructions to request support. Outside the U.S., United Kingdom, Ireland, Mexico, or Benelux contact the dealer of record.



UL 1573
CSA C22.2 No. 166
E113093